

SOLAR'S MOST TRUSTED

A silhouette of a person climbing a cliff edge is shown against a bright sunset sky. The sun is low on the horizon, creating a lens flare effect. The background features a range of mountains under a hazy, golden light.

REC ALPHA PANELS INSTALLATION MANUAL

FOR ALL REC ALPHA SOLAR PANELS CERTIFIED
ACCORDING TO IEC 61215 & UL 61730 STANDARDS:

- REC Alpha Series
- REC Alpha Black Series
- REC Alpha Pure Series
- REC Alpha 72 Series

CONTENTS

INTRODUCTION	3
SAFETY MEASURES	4
PANEL HANDLING	5
CHOOSING AN INSTALLATION LOCATION	5
ELECTRICAL INSTALLATION	6
MECHANICAL INSTALLATION	6
PANEL INSTALLATION	7
Securing of panels	7
Installation of REC Alpha Series panels	8
Mounting REC Alpha Series panels with continuous rails parallel to short side of the panel	8
Mounting REC Alpha Series panels with continuous rails parallel to long side of the panel	9
Mounting REC Alpha Series panels with short rails	10
Installation of REC Alpha Pure Series panels	11
Mounting REC Alpha Pure Series panels with continuous rails parallel to short side of the panel	11
Mounting REC Alpha Pure Series panels with continuous rails parallel to long side of the panel	12
Mounting REC Alpha Pure Series panels with short rails	13
Installation of REC Alpha 72 Series panels	14
Mounting REC Alpha 72 Series panels with continuous rails parallel to short side of the panel	14
Mounting REC Alpha 72 Series panels with short rails parallel to short side of the panel	15
Mounting methods: Slide in systems	16
Mounting methods: Mounting holes	16
Drainage holes	17
CONNECTIONS AND CONNECTORS	18
CABLE MANAGEMENT	18
PANEL MAINTENANCE	19
RECYCLING	19
DISPOSAL OF OLD ELECTRICAL AND ELECTRONIC EQUIPMENT	19
PANEL CHARACTERISTICS	20
Technical Properties: REC Alpha Series	20
Technical Properties: REC Alpha Black Series	21
Technical Properties: REC Alpha Pure Series	22
Technical Properties: REC Alpha 72 Series	23
ANNEX 1: INSTALLATIONS ON WATER PLATFORMS	24
ANNEX 2: INSTALLATIONS USING MODULE LEVEL POWER ELECTRONICS	25
ANNEX 3: SIX-POINT MOUNTING CONFIGURATION	26
DOCUMENT HISTORY	27

LIST OF FIGURES

Fig. 1: Clamp specifications	7	Fig. 12: Mounting holes: REC Alpha 72 Series	16
Fig. 2: Panel quarter divisions	7	Fig. 13: Device specifications for mounting holes	16
Fig. 3: Clamping of REC Alpha Series panels with rails parallel to short side of the panel	8	Fig. 14: Mounting hole installation example	16
Fig. 4: Clamping of REC Alpha Series panels with rails parallel to long side of the panel	9	Fig. 15: Drainage and grounding holes	17
Fig. 5: Clamping of REC Alpha Series panels using a short support	10	Fig. 16: Grounding lug dimensions and fastening torque	17
Fig. 6: Clamping of REC Alpha Pure Series panels with rails parallel to short side of the panel	11	Fig. 17: Minimum cable bend radius	18
Fig. 7: Clamping of REC Alpha Pure Series panels with rails parallel to long side of the panel	12	Fig. 18: Panel dimensions: REC Alpha Series	20
Fig. 8: Clamping of REC Alpha Pure Series panels using short rails	13	Fig. 19: Panel dimensions: REC Alpha Black Series	21
Fig. 9: Clamping of REC Alpha 72 Series panels with rails parallel to short side of the panel	14	Fig. 20: Panel dimensions: REC Alpha Pure Series	22
Fig. 10: Clamping of REC Alpha 72 Series panels using short rails	15	Fig. 21: Panel dimensions: REC Alpha 72 Series	23
Fig. 11: Mounting holes: REC Alpha Series	16	Fig. 22: REC Alpha Series MLPE device installation zones	25
		Fig. 23: REC Alpha 72 Series MLPE device installation zones	25
		Fig. 24: Six-point mounting configuration clamping zones	26

INTRODUCTION



Thank you for choosing REC photovoltaic panels for your installation. REC Alpha solar panels are ideal for delivering long-lasting and reliable power output. They have been created through intelligent design and are manufactured to the highest quality and environmental standards. With correct installation and maintenance, REC panels will provide decades of clean and renewable energy.

Please read this entire manual carefully. It contains critical information on safety, as well as detailed instructions for the installation, operation and maintenance of the panels. Failure to follow these procedures will invalidate the warranty (www.recgroup.com/warranty). Review all instructions and safety notes in this manual before working on the system. Failure to do so may lead to injury or damage to property.

HOW TO USE THIS MANUAL

This manual describes the procedures for the terrestrial installation of all REC Alpha solar panels certified according to IEC 61215 & UL 61730 standards. This includes all product variants (indicated by the appropriate suffix in the panel name) e.g., a white or black backsheet. The installed panel is considered to be in compliance with IEC 61215 & UL 61730 only when mounted in the manner specified by this installation manual. Note that any panel without a frame (laminated) is not considered to comply with the requirements of IEC 61215 & UL 61730 unless mechanically installed with hardware that has been tested and evaluated with the panel under this standard or by a field inspection certifying that the installed panel complies with the requirements of IEC 61215 & UL 61730.

Except where specifically stated, the information and drawings in this manual refer to all frame, backsheet, and cell types; the illustrations are only a generic representation of the instructions regardless of color or exact design. Throughout the manual, you will see sections which highlight important information or notes:

 DANGER
Indicates potential for damage to personal safety.
 CAUTION
Indicates potential for damage to the array or property.
 NOTE
Indicates important notes to help with the installation.

YOUR RESPONSIBILITY AS AN INSTALLER

Installers are responsible for the safe and effective installation and operation of the system and for adhering to all applicable local standards and regulations. Prior to installation installers must check all current regulations and permits concerning solar installations and ensure all local directives are observed. Furthermore, installers are responsible for the following:

- Only qualified personnel must perform work on photovoltaic systems such as installation, commissioning, maintenance and repairs
- Be sure to follow the safety instructions for all system components
- Ensuring the REC panels are in a suitable condition for use and appropriate for the particular installation and environment
- Using only parts that comply with the specifications set out in this manual
- Ensuring a safe installation of all aspects of the electrical array
- All tools and equipment should be properly maintained and inspected prior to use

As this manual may contain instructions for different product variants, ensure you follow the instructions for the correct product where specified.

SUPPORT

Do not attempt to install REC solar panels if you are unsure of the procedure or suitability. For further support, questions or guidance with your installation, please call your distributor or contact your REC sales office, which can be found at: www.recgroup.com/contacts.

LIABILITY DISCLAIMER

REC SOLAR PTE. LTD. accepts no liability for the usability and functionality of its photovoltaic panels if the instructions in this guide are not observed. Since compliance with this guide and the conditions and methods of installation, operation, use and maintenance of the panels are not checked or monitored by REC SOLAR PTE. LTD., REC SOLAR PTE. LTD. accepts no liability for damage arising from improper application or incorrect installation, operation or maintenance. This does not apply to damages due to a panel fault, in cases of loss of life, bodily injury or damage to health or in the event of a grossly negligent breach of obligations on the part of REC SOLAR PTE. LTD. and/or in the event of an intentional or grossly negligent breach of obligations by a legal representative or vicarious agent. REC reserves the right to make changes or amendments to this manual at any time, without prior notice.

This document may be produced in different languages. If there is any conflict, the English language version shall be definitive.

LIMITED WARRANTY

The REC Limited Warranty is available to download from www.recgroup.com/warranty. Ignoring any of the instructions in this manual may be classed as improper installation or use and invalidate the Warranty Terms and Conditions. If you have any questions about installation and the Warranty validity, please contact REC.

SAFETY MEASURES

Installers are responsible for the safe and effective installation and operation of the system and for adhering to all applicable local and national standards and regulations. All relevant local codes and regulations should be referred to and observed.



DANGER - Electrical shock

Solar panels generate direct current (DC). Once current is flowing, breaking a connection (e.g., disconnecting two panels) can cause an electrical arc. Unlike low voltage AC wiring, DC arcs are not self-extinguishing; they are potentially lethal burn and fire hazards, capable of high temperatures that can destroy contacts and connectors:

- Isolate the system and remove/open the inverter AC fuse/circuit breaker from the grid before carrying out any maintenance or repair work.
- Follow inverter manufacturer's installation, handling and operating instructions.
- High-voltage components need sufficient time to discharge. Wait for the time specified by the manufacturer before commencing work.
- Do not use a panel which is broken or damaged. If the panel front glass is broken or laminate back sheet is damaged, it can expose personnel to hazardous voltages.

SAFETY IN THE WORKING AREA

Installation of REC solar panels may involve working on rooftops or raised platforms. Ensure all local regulations regarding working at heights and fall protection are followed. Before beginning work on an installation, ensure all working surfaces are structurally sound and capable of bearing the weight of employees and required equipment.

Preventing current generation

To prevent the panels automatically generating current (electricity) when exposed to light, shield the system with a non-transparent cover during installation, maintenance or repair work.

Specific hazards of DC electricity

The voltage produced by a single panel, and panels connected in series (voltages added together), or in parallel (currents added together) can be dangerous. Although the fully insulated plug contacts on the panel's output cables provide touch-safe protection, the following points must be observed during handling to avoid the risk of sparking, fire hazards, burns and lethal electric shocks:

- Exercise extreme caution when wiring panels and look out for damaged or dirty cables etc,
- Never insert metallic or other conductive objects into plugs or sockets,
- Ensure that all electrical connections are completely dry before assembly,
- Keep all materials, tools, and working conditions dry and tidy,
- Use appropriate safety equipment e.g., non-slip footwear, insulated gloves and insulated tools,
- Solar panels produce current when exposed to sunlight. Do not connect the system to the inverter during solar exposure.

PANEL HANDLING

In order to avoid damage, all REC solar panels should be handled with care and protected from damage at all times. All warnings and instructions on the packaging should be observed. Follow these guidelines when unpacking, transporting, carrying, installing or storing panels:

- Record the serial numbers prior to installation and note the information in the system documentation,
- Carry the panels using both hands and do not use the junction box or cables as a grip,
- Do not allow the panels to sag or bow under their own weight when being carried,
- Do not subject panels to loads or stresses, e.g., leaning on them or through the placing of weight on them,
- Do not stand or walk on the panels,
- Avoid dropping the panels as any damage caused may be unseen,
- Keep all electrical contacts clean and dry,
- Do not apply force to the backsheet,
- Avoid using sharp or pointed objects if panels require marking,
- Never apply paints, adhesives or detergents to the front or rear of the panel,
- Do not use any solar panel that is damaged or has been tampered with,
- Never attempt to disassemble, modify, or adapt the panels or labels in any way as this will void the warranty.

NOTE

Use clean and protective gloves when handling the panel as this will avoid the transfer of any fingerprints or soiling to the highly-sensitive and anti-reflective glass surface, ensuring improved light transmission and avoiding any contamination.

The pallet packaging is not water- or weatherproof. Prior to installation, and to avoid damage or degradation to the packaging or panel components, pallets and panels must be stored in a controlled environment, ideally internal, where it is protected from the elements, e.g., rain, dust, and direct sunlight. If overnight storage in an uncontrolled environment is unavoidable, the panels and the pallet packaging must be protected from direct exposure to the elements and from contact with the ground, including earth, mud etc.

CHOOSING AN INSTALLATION LOCATION

REC solar panels are designed to provide decades of durable and stable output in installations up to 6500 ft (2000 m) above sea level. Ambient operating temperatures must be between -40° - 185°F (-40° and +85°C).

The panels are not suitable for installation in potentially hazardous locations nor should they be installed in the following locations:

- Near sources of flammable gas or vapor e.g., gas containers or spray paint facilities,
- Near open flames,
- Where the panels are exposed to direct contact with salt water/spray,
- Under water or in water features,
- Where exposed to sulfur e.g., near sulfur springs or volcanoes,
- Where exposed to artificially concentrated sunlight,
- Where the panels may be exposed to harmful chemicals.

NOTE

For further information regarding installations on water platforms, e.g., floating pontoons, see Annex 1 at the rear of this manual.

ELECTRICAL INSTALLATION

DANGER - Electrical shock

Safety is paramount when working on the electrical installation. Always follow the electrical requirements to avoid the risk of sparking, fire hazards, burns and lethal electric shocks.

ELECTRICAL REQUIREMENTS

Application Class

REC solar panels are rated for use in Electrical Application Class A, Protection Safety Class II; at hazardous levels of voltage (>35V), current(>8A) and power (>240W) where general contact access is anticipated (panels qualified for safety through UL 61730-1 and -2).

System Requirements

REC solar panels are only for use where they meet the specific technical requirements of the complete system. Ensure other components will not cause mechanical or electrical damage to the panels. Only panels of the same type and power class should be connected.

String configuration

When connecting panels in a string, plan and execute according to the inverter manufacturer's instructions. The number of panels connected to an inverter must not exceed the voltage limits and operating range permitted by the manufacturer, nor under any circumstance exceed the maximum system voltage as stated in the technical specifications for the product at the rear of this manual. The maximum system fuse rating (overcurrent protection rating) and the maximum reverse current for each panel can be found in the technical specifications for the product at the rear of this manual.

The maximum number of panels in a string can be calculated by dividing the maximum system voltage of the panel by its V_{oc} accounting for the lowest ambient temperature at site, e.g.: for a 1000V system, if the lowest ambient temperature is 15°C, the panel has a V_{oc} of 44.3 V and a temperature coefficient of V_{oc} of -0.24%/°C, the maximum panels per string is 22 ($\Delta T^{\circ}C = 25^{\circ} - 15^{\circ} = 10^{\circ}$; $10^{\circ} \times 0.24 = 2.4\%$; $44.3 + 2.4\% = 45.4$; $1000 V / 45.4 = 22.0$, so a total of 22 panels or 976 V). Qualified system designers can make exact calculations that account for specific project requirements and site conditions.

String connection

If panels are connected in series, they must have the same ampere rating. If panels are connected in parallel, they must have the same voltage rating. The maximum number of panels that can be connected in series or parallel depends upon system design, type of inverter and environmental conditions. Panel and string configuration must correspond to the specifications of other system components e.g., inverter. Refer to the reverse current rating of the panel as indicated in the technical characteristics section to the rear of this manual or on the panel datasheet.

Wiring

Wiring installation shall be in accordance with the National Electric Code (NEC) (or CSA C22.1, Safety Standard for Electrical Installations, Canadian Electrical Code, Part 1 where applicable). To minimize voltage surges (e.g., indirect lightning strikes), cables of the same string must be bundled together so loops are as small as possible. String configurations must be checked before commissioning. If open circuit voltage (V_{oc}) and short circuit current (I_{sc}) deviate from specification, this may indicate a configuration fault. Correct DC polarity must be observed at all times.

Electrical Ratings

Electrical ratings are within a specific tolerance of measured values at Standard Test Conditions (STC) as given in the technical characteristics for each panel at the rear of this manual. Under normal conditions, a photovoltaic panel is likely to experience conditions that produce more current and/or voltage than reported at STC. The requirements of the NEC in Article 690 must be followed to address these increased outputs. In installations not under the requirements of the NEC, the values of I_{sc} and V_{oc} marked on the panels must be multiplied by a factor of 1.25 (or according to local regulations) when determining component voltage ratings, conductor ampacities, overcurrent device ratings and size of controls connected to the PV output.

MECHANICAL INSTALLATION

FIRE GUIDELINES

The REC solar panels covered by this manual have a Class C (referencing UL 790) fire classification. The REC Alpha Series and REC Alpha Pure Series are rated Type 2 fire classification according to IEC 61730-2:2016 (ref. ANSI/UL 1703); The REC Alpha 72 XV Series is rated Type 1 fire classification according to IEC 61730-2:2016 (ref. ANSI/UL 1703). The fire performance rating of the panels is only valid when mounted in the manner specified in this installation manual. The complete system fire class rating is to be achieved by the combination of panel fire performance type and UL2703 certified mounting structure for a non-BIPV panel. Please refer to mounting structure UL2703 listing for System Fire Classification. Any specific limitations on the inclination or accessories required to maintain a specific System Fire Class Rating must be clearly specified in the mounting system manufacturer's installation instructions and UL2703 certification. Utilize the following fire safety guidelines when installing REC panels:

- Check with all relevant local authorities for fire safety requirements for any building or structure on to which the panels will be installed,
- The system design must ensure that it can be easily accessed in the event of a building fire,
- Check with relevant authorities for applicable regulations concerning setbacks or other placement restrictions that may apply for roof-mounted arrays,
- The use of DC ground fault interrupters is recommended. This may also be required by local and national codes,
- All electrical appliances are a fire risk. The panel must be mounted over a fire retardant roof covering rated for the application and a distance of at least 0.8 in (20 mm) (2.4 in / 60 mm for REC Alpha 72 Series) between the panel and the mounting surface, to allow the free circulation of air beneath the panels at all times.

ORIENTATION

The optimal mounting position of a panel results in the sun's rays falling perpendicular (i.e., at 90°) to the surface. To maximize system output, panels should be installed at the optimum orientation and tilt angle. The specifics of this depend on location and can be calculated by a qualified system designer. All panels in a string should, wherever possible, have the same orientation and tilt to ensure the system does not underperform due to mismatched outputs. Dependent on local conditions, a lower angle of installation will potentially increase the requirement for regular cleaning.

NOTE

The IP rating of the junction box provides a level of protection that allows panels to be mounted in any orientation.

PANEL INSTALLATION

REC solar panels are designed for capturing solar radiation and can be installed where they conform to all local structural regulations. If installing REC solar panels in overhead or vertical constructions, the installer must ensure that all local building codes and regulations specific to such installations are correctly followed. There are different options for securing REC solar panels depending on the design of the array. Mounting hardware is not supplied by REC. Ensure the mounting structure can withstand anticipated wind and snow loads. Follow the mounting hardware manufacturer's instructions and recommendations at all times.

i NOTE

Panels must be installed so that the cells are not shaded as this will drastically reduce electrical output. If partial shading is inevitable at certain times of the day or year, it must be kept to an absolute minimum. Remove any labels or stickers that may be on the front of the panels and ensure no residue is left on the glass.

i NOTE

Common hardware items such as nuts, bolts, star washers, lock washers and the like have not been evaluated for electrical conductivity or for use as grounding devices and should be used only for maintaining mechanical connections and holding electrical grounding devices in the proper position for electrical conductivity. Such devices, where supplied with the panel and evaluated through the requirements in IEC 61215 & UL 61730, may be used for grounding connections in accordance with the instructions provided with the panel.

⚠ CAUTION

There must be a minimum clearance gap between the uppermost part of the installation surface (e.g., rooftop) and the lowest part of the panel (i.e., underside of panel frame) to avoid any damage to the panel and to ensure sufficient airflow for cooling, helping to improve performance.

Minimum clearance gap REC Alpha & Alpha Pure Series: 0.8 in (20 mm)

Minimum clearance gap REC Alpha 72 Series: 2.4 in (60 mm)

The surface below the panels must be kept clear of any objects that may cause damage to the panel.

SECURING OF PANELS

A typical installation of solar panels will be carried out with suitable rails and clamps. Other types of panel support, e.g., plates, must meet the same specifications. Such installations have been found to be in compliance with IEC 61215 & IEC 61730 requirements for the below stated maximum test loads:

REC Alpha & Alpha Pure Series panels: +7000 Pa downwards pressure and -4000 Pa upwards pressure (+4666 Pa/-2666 Pa design loads).

REC Alpha 72 Series panels: +5400 Pa downwards pressure and -2400 Pa upwards pressure (+3600 Pa/-1600 Pa design loads).

Site-specific factors such as high wind or snow levels must be taken into consideration to ensure this limit is not exceeded.

When installing on mounting rails, ensure they run underneath the panel and provide support to the frame. The positioning of the rail must ensure that the minimum clamp grip length (fig. 1) and the central point of the fixation, e.g., the bolt, is fully within the required clamping zone as indicated on the following pages.

REC modules must be secured with a torque as shown in the table below (fig. 1). Clamp installation must be carried out according to the manufacturer's instructions, including specific hardware and torque requirements. Ensure the clamps used are suitable for the planned installation and expected system design loads.

- The grip area must not extend onto the panel glass and/or cause cell shading,
- Avoid the application of excessive pressure to prevent frame deformation,
- The panel must be secured, e.g., clamped, at least once in each of the four marked zones shown below (fig. 2).

Fig. 1: Clamp specifications

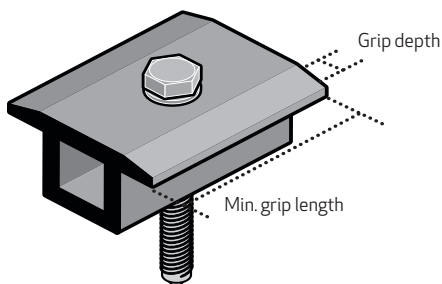

Specifications	Length
Grip depth	0.2 - 0.4 in (5 - 10 mm)
Min. grip length	1.6 in (40 mm)
Torque	12 - 25 Nm (106-221 lbf/in)

Fig. 2: Panel quarter divisions

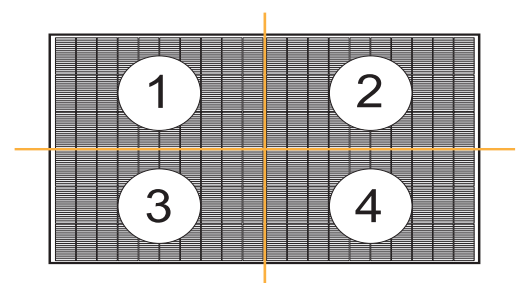

i NOTE

- In areas of snow build-up, panels can be subjected to forces in excess of the stated limit even when snow depth does not appear extreme, potentially causing damage to the panel. If the installation may be affected by this, further panel support is recommended, especially on the lower row of panels.
- In the case of any questions regarding mounting systems, or if the mounting system to be used does not match any of the instructions shown in this installation manual, please contact REC for further support.



INSTALLATION OF REC ALPHA SERIES PANELS

MOUNTING REC ALPHA SERIES PANELS WITH CONTINUOUS RAILS PARALLEL TO SHORT SIDE OF THE PANEL

A continuous rail (or other support structure) spans the complete underside of the panel.

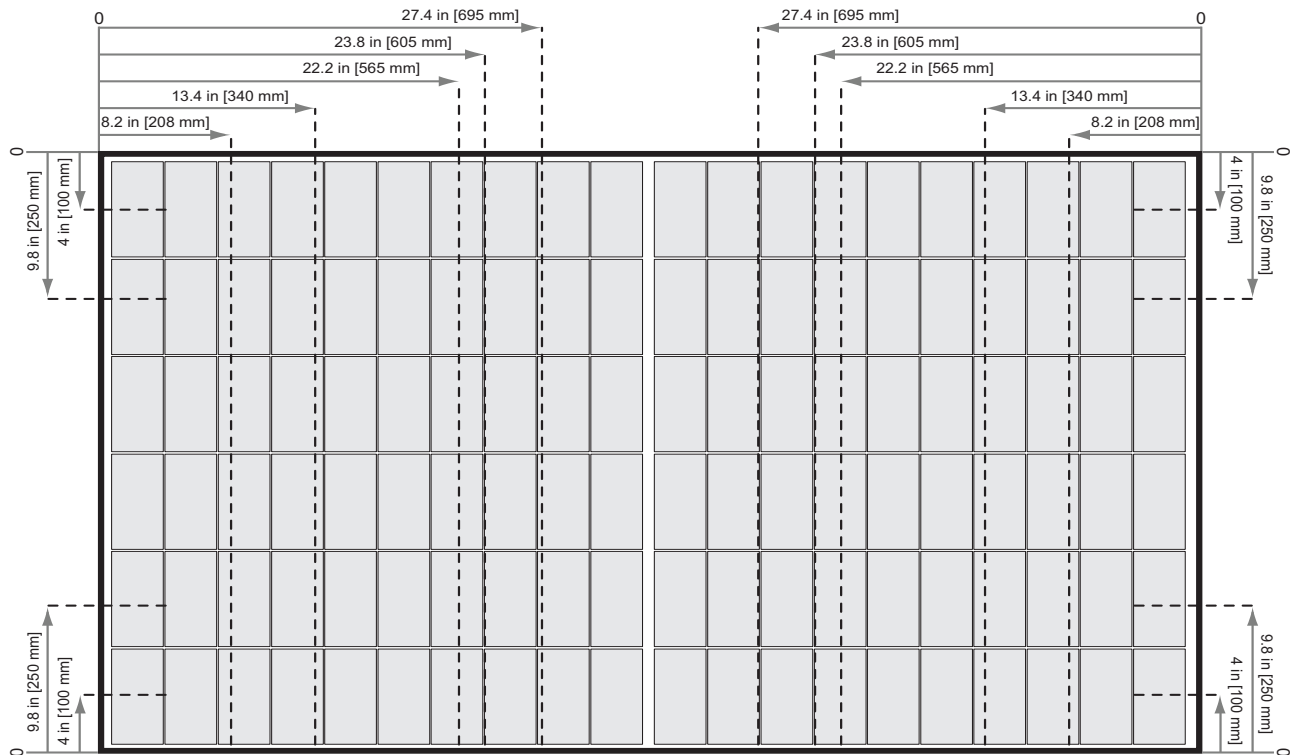
Fig. 3: Clamping of REC Alpha Series panels with rails parallel to short side of the panel

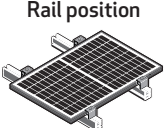
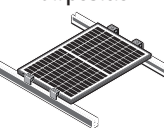

Legend	Clearance Gap		0.8 - 1.6 in (20-40 mm)	1.6 - 2.4 in (40-60 mm)	>2.4 in (>60 mm)	<0.8 in (<20 mm)				
			Test Load (Design Load)	Test Load (Design Load)	Test Load (Design Load)	Test Load (Design Load)				
 Rail position Long Side Mounting	0 - 8.2 in (0 - 208 mm)	8.2 - 13.4 in (208 - 340 mm)	13.4 - 22.2 in (340 - 565 mm)	22.2 - 23.8 in (565 - 605 mm)	23.8 - 27.4 in (605 - 695 mm)	X	+1200 Pa / -1200 Pa* (+800 Pa / -800 Pa)	+2400 Pa / -2400 Pa (+1600 Pa / -1600 Pa)	X	
						X	+1800 Pa / -1800 Pa* (+1200 Pa / -1200 Pa)	+4200 Pa / -2400 Pa (+2800 Pa / -1600 Pa)	+5400 Pa / -2400 Pa (+3600 Pa / -1600 Pa)	X
						X	+1800 Pa / -1800 Pa* (+1200 Pa / -1200 Pa)	+6200 Pa / -4000 Pa (+4133 Pa / -2666 Pa)	+7000 Pa / -4000 Pa (+4666 Pa / -2666 Pa)	X
						X	+1200 Pa / -1200 Pa* (+800 Pa / -800 Pa)	+3000 Pa / -2400 Pa (+2400 Pa / -1600 Pa)	+5400 Pa / -2400 Pa (+3600 Pa / -1600 Pa)	X
						X	+2400 Pa / -2400 Pa (+1600 Pa / -1600 Pa)	+2400 Pa / -2400 Pa (+1600 Pa / -1600 Pa)	+2400 Pa / -2400 Pa (+1600 Pa / -1600 Pa)	X
 Rail position Short Side Mounting	0 - 4 in (0 - 100 mm)	4 - 9.8 in (100 - 250 mm)				X	+1200 Pa / -1200 Pa* (+800 Pa / -800 Pa)	+1600 Pa / -1600 Pa* (+1066 Pa / -1066 Pa)	X	
						X	+800 Pa / -800 Pa* (+533 Pa / -533 Pa)	+2400 Pa / -2400 Pa (+1600 Pa / -1600 Pa)	X	
		Once a module is secured in each of the 4 zones (fig. 2), additional clamps, i.e., ≥5, may be freely located on panel frame without affecting the warranty. Loads marked with a * were not certified as part of IEC 61215/UL 61730 testing; these have been evaluated by REC's internal testing process.								

CAUTION



The center point of each clamp and the minimum grip length must be fully located in the same clamping zones to be rated to that load (fig. 3). If the panel is secured in zones with different load values, it is rated to the lowest load value only.

MOUNTING REC ALPHA SERIES PANELS WITH CONTINUOUS RAILS PARALLEL TO LONG SIDE OF THE PANEL

A continuous rail (or other support structure) spans the complete underside of the panel.

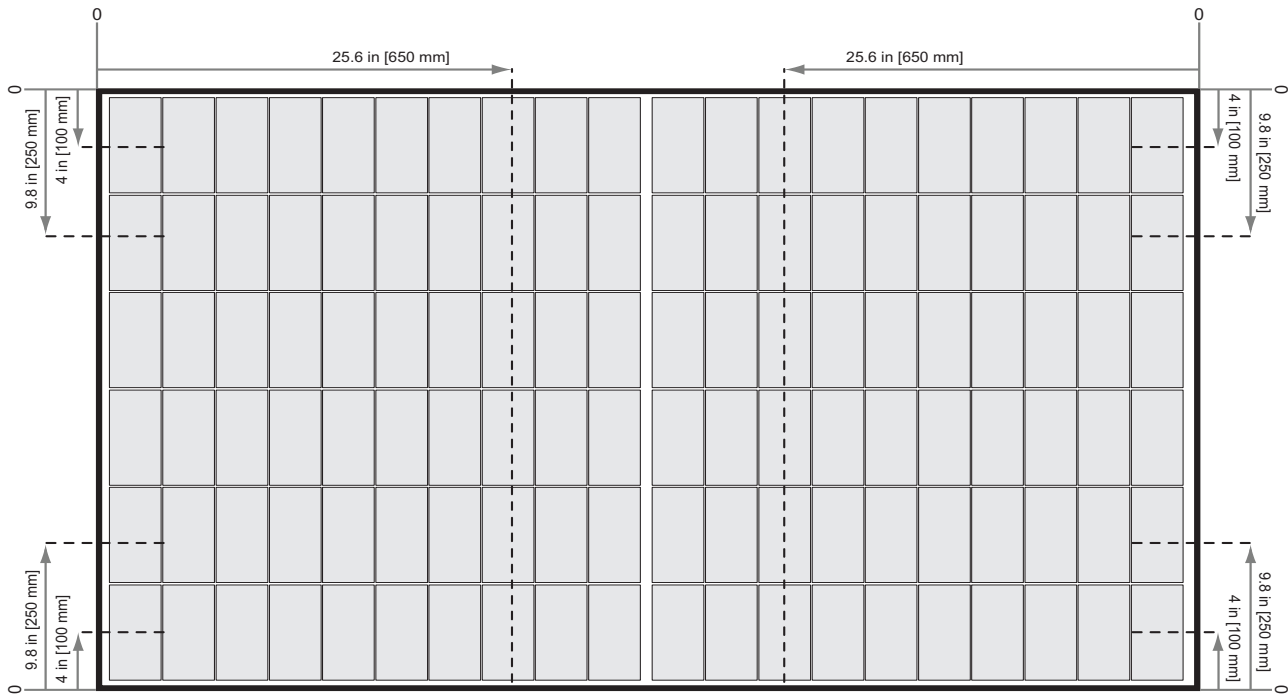
Fig. 4: Clamping of REC Alpha Series panels with rails parallel to long side of the panel



Legend	Clearance Gap		0.8 - 1.6 in (20-40 mm)	1.6 - 2.4 in (40-60 mm)	>2.4 in (>60 mm)	<0.8 in (<20 mm)
			Test Load (Design Load)	Test Load (Design Load)	Test Load (Design Load)	Test Load (Design Load)
 Rail position Long Side Mounting	0 - 25.6 in (0 - 650 mm)		+1200 Pa / -1200 Pa* (+800Pa/-800Pa)	+3000 Pa / -2400 Pa (+2400Pa/-1600Pa)	+5400 Pa / -2400 Pa (+3600Pa/-1600Pa)	X
 Rail position Short Side Mounting	0 - 4 in (0 - 100 mm)		X	+1200 Pa / -1200 Pa* (+800Pa/-800Pa)	+1600 Pa / -1600 Pa* (+1066Pa/-1066Pa)	X
	4 - 9.8 in (100 - 250 mm)		X	+800 Pa / -800 Pa* (+533Pa/-533Pa)	+2400 Pa / -2400 Pa (+1600Pa/-1600Pa)	X
	Once a module is secured in each of the 4 zones (fig. 2), additional clamps, i.e., ≥5, may be freely located on panel frame without affecting the warranty. Loads marked with a * were not certified as part of IEC 61215/UL 61730 testing; these have been evaluated by REC's internal testing process.					

CAUTION

The center point of each clamp and the minimum grip length must be fully located in the same clamping zones to be rated to that load (fig. 4). If the panel is secured in zones with different load values, it is rated to the lowest load value only.

MOUNTING REC ALPHA SERIES PANELS WITH SHORT RAILS

A short rail (or other short support structure) has a minimum length of 25 mm and does not span the complete underside of a panel.

Fig. 5: Clamping of REC Alpha Series panels using a short support

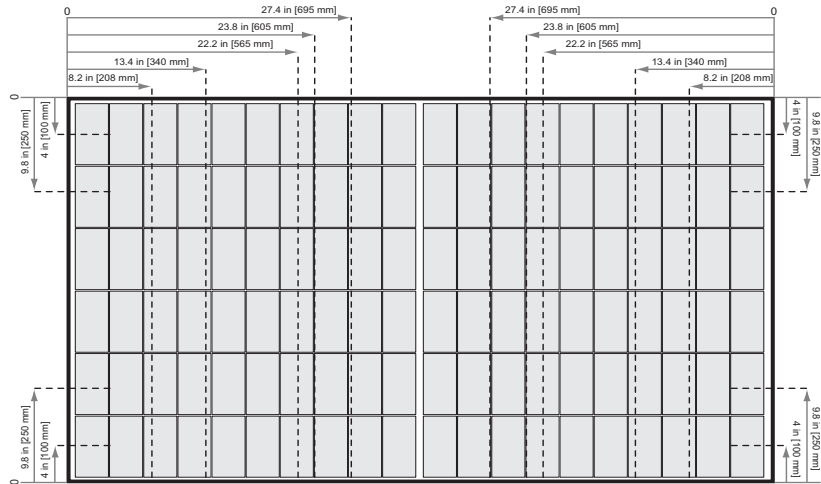

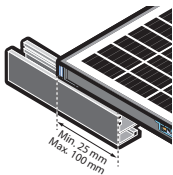
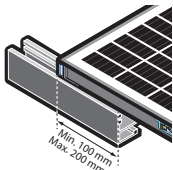
Legend	Clearance Gap	Clamping zone				
		0.8 - 1.6 in (20-40 mm)	1.6 - 2.4 in (40-60 mm)	>2.4 in (>60 mm)	<0.8 in (<20 mm)	
		Test Load (Design Load)	Test Load (Design Load)	Test Load (Design Load)	Test Load (Design Load)	
Rail length under module 1 - 3.9 in (25 - 100 mm) 	Long Side Mounting	0 - 8.2 in (0 - 208 mm)	X	+1200 Pa / -1200 Pa* (+800 Pa / -800 Pa)	+1600 Pa / -1600 Pa* (+1066 Pa / -1066 Pa)	X
		8.2 - 13.4 in (208 - 340 mm)	+1200 Pa / -1200 Pa* (+800 Pa / -800 Pa)	+4100 Pa / -2400 Pa (+2733 Pa / -1600 Pa)	+4500 Pa / -2400 Pa (+3000 Pa / -1600 Pa)	X
		13.4 - 22.2 in (340 - 565 mm)	+1200 Pa / -1200 Pa* (+800 Pa / -800 Pa)	+3000 Pa / -3000 Pa (+2000 Pa / -2000 Pa)	+4200 Pa / -4000 Pa (+2800 Pa / -2666 Pa)	X
		22.2 - 23.8 in (565 - 605 mm)	+1200 Pa / -1200 Pa* (+800 Pa / -800 Pa)	+2400 Pa / -2400 Pa (+1600 Pa / -1600 Pa)	+3600 Pa / -2400 Pa (+2400 Pa / -1600 Pa)	X
		23.8 - 27.4 in (605 - 695 mm)	+1800 Pa / -1800 Pa* (+1200 Pa / -1200 Pa)	+2400 Pa / -2400 Pa (+1600 Pa / -1600 Pa)	+2400 Pa / -2400 Pa (+1600 Pa / -1600 Pa)	X
	Short Side Mounting	0 - 4 in (0 - 100 mm)	X	+1200 Pa / -1200 Pa* (+800 Pa / -800 Pa)	+1600 Pa / -1600 Pa* (+1066 Pa / -1066 Pa)	X
		4 - 9.8 in (100 - 250 mm)	X	+800 Pa / -800 Pa* (+533 Pa / -533 Pa)	+2400 Pa / -2400 Pa (+1600 Pa / -1600 Pa)	X
	Rail length under module 3.9 - 7.9 in (100 - 200 mm) 	Long Side Mounting	0 - 8.2 in (0 - 208 mm)	X	+1200 Pa / -1200 Pa* (+800 Pa / -800 Pa)	+1600 Pa / -1600 Pa* (+1066 Pa / -1066 Pa)
8.2 - 13.4 in (208 - 340 mm)			+1200 Pa / -1200 Pa* (+800 Pa / -800 Pa)	+3600 Pa / -2400 Pa (+2400 Pa / -1600 Pa)	+3600 Pa / -2400 Pa (+2400 Pa / -1600 Pa)	X
13.4 - 22.2 in (340 - 565 mm)			+1200 Pa / -1200 Pa* (+800 Pa / -800 Pa)	+3000 Pa / -3000 Pa (+2000 Pa / -2000 Pa)	+3000 Pa / -3000 Pa (+2000 Pa / -2000 Pa)	X
22.2 - 23.8 in (565 - 605 mm)			+1200 Pa / -1200 Pa* (+800 Pa / -800 Pa)	+2400 Pa / -2400 Pa (+1600 Pa / -1600 Pa)	+3600 Pa / -2400 Pa (+2400 Pa / -1600 Pa)	X
23.8 - 27.4 in (605 - 695 mm)			+1800 Pa / -1800 Pa* (+1200 Pa / -1200 Pa)	+2400 Pa / -2400 Pa (+1600 Pa / -1600 Pa)	+2400 Pa / -2400 Pa (+1600 Pa / -1600 Pa)	X
Short Side Mounting		0 - 4 in (0 - 100 mm)	X	+1200 Pa / -1200 Pa* (+800 Pa / -800 Pa)	+1600 Pa / -1600 Pa* (+1066 Pa / -1066 Pa)	X
		4 - 9.8 in (100 - 250 mm)	X	+800 Pa / -800 Pa* (+533 Pa / -533 Pa)	+2400 Pa / -2400 Pa (+1600 Pa / -1600 Pa)	X



Once a module is secured in each of the 4 zones (fig. 2), additional clamps, i.e., ≥ 5 , may be freely located on panel frame without affecting the warranty. Loads marked with a * were not certified as part of IEC 61215 / UL 61730 testing; these have been evaluated by REC's internal testing process.

CAUTION

The center point of each clamp and the minimum grip length must be fully located in the same clamping zones to be rated to that load (fig. 5). If the panel is secured in zones with different load values, it is rated to the lowest load value only.



INSTALLATION OF REC ALPHA PURE SERIES PANELS

MOUNTING REC ALPHA PURE SERIES PANELS WITH CONTINUOUS RAILS PARALLEL TO SHORT SIDE OF THE PANEL

A continuous rail (or other support structure) spans the complete underside of the panel.

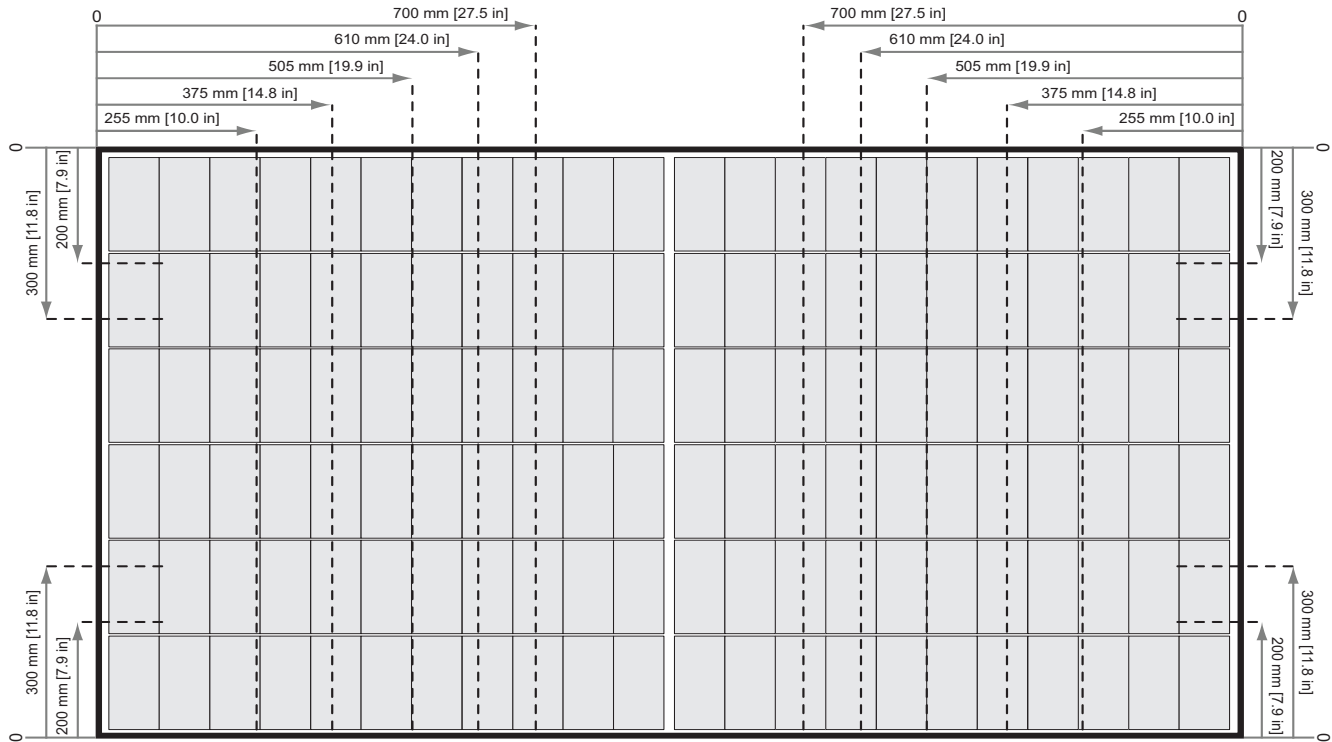
Fig. 6: Clamping of REC Alpha Pure Series panels with rails parallel to short side of the panel

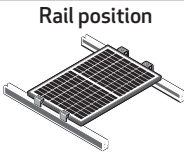

Legend	Clearance Gap		0.8 - 1.6 in (20-40 mm)	1.6 - 2.4 in (40-60 mm)	>2.4 in (>60 mm)	<0.8 in (<20 mm)
			Test Load (Design Load)	Test Load (Design Load)	Test Load (Design Load)	Test Load (Design Load)
Rail position 	Long Side Mounting	0 - 10.0 in (0 - 255 mm)	X	+1200 Pa / -1200 Pa * (+800Pa/-800Pa)	+2400 Pa / -2400 Pa (+1600Pa/-1600Pa)	X
		10.0 - 14.8 in (255 - 375 mm)	+1800 Pa / -1800 Pa * (+1200Pa/-1200Pa)	+4200 Pa / -2400 Pa (+2800Pa/-1600Pa)	+5400 Pa / -2400 Pa (+3600Pa/-1600Pa)	X
		14.8 - 19.9 in (375 - 505 mm)	+1800 Pa / -1800 Pa * (+1200Pa/-1200Pa)	+6200 Pa / -4000 Pa (+4133Pa/-2666Pa)	+7000 Pa / -4000 Pa (+4666Pa/-2666Pa)	X
		19.9 - 24.0 in (505 - 610 mm)	+1200 Pa / -1200 Pa * (+800Pa/-800Pa)	+3000 Pa / -2400 Pa (+2400Pa/-1600Pa)	+5400 Pa / -2400 Pa (+3600Pa/-1600Pa)	X
		24.0 - 27.5 in (610 - 700 mm)	+2400 Pa / -2400 Pa (+1600Pa/-1600Pa)	+2400 Pa / -2400 Pa (+1600Pa/-1600Pa)	+2400 Pa / -2400 Pa (+1600Pa/-1600Pa)	X
Rail position 	Short Side Mounting	0 - 7.9 in (0 - 200 mm)	X	+1200 Pa / -1200 Pa * (+800Pa/-800Pa)	+1600 Pa / -1600 Pa * (+1066Pa/-1066Pa)	X
		7.9 - 11.8 in (200 - 300 mm)	X	+800 Pa / -800 Pa * (+533Pa/-533Pa)	+2400 Pa / -2400 Pa (+1600Pa/-1600Pa)	X
		Once a module is secured in each of the 4 zones (fig. 2), additional clamps, i.e., ≥5, may be freely located on panel frame without affecting the warranty. Loads marked with a * were not certified as part of IEC 61215/61730 testing; these have been evaluated by REC's internal testing process.				



CAUTION
 The center point of each clamp and the minimum grip length must be fully located in the same clamping zones to be rated to that load (fig. 6). If the panel is secured in zones with different load values, it is rated to the lowest load value only.

MOUNTING REC ALPHA PURE SERIES PANELS WITH CONTINUOUS RAILS PARALLEL TO LONG SIDE OF THE PANEL

A continuous rail (or other support structure) spans the complete underside of the panel.

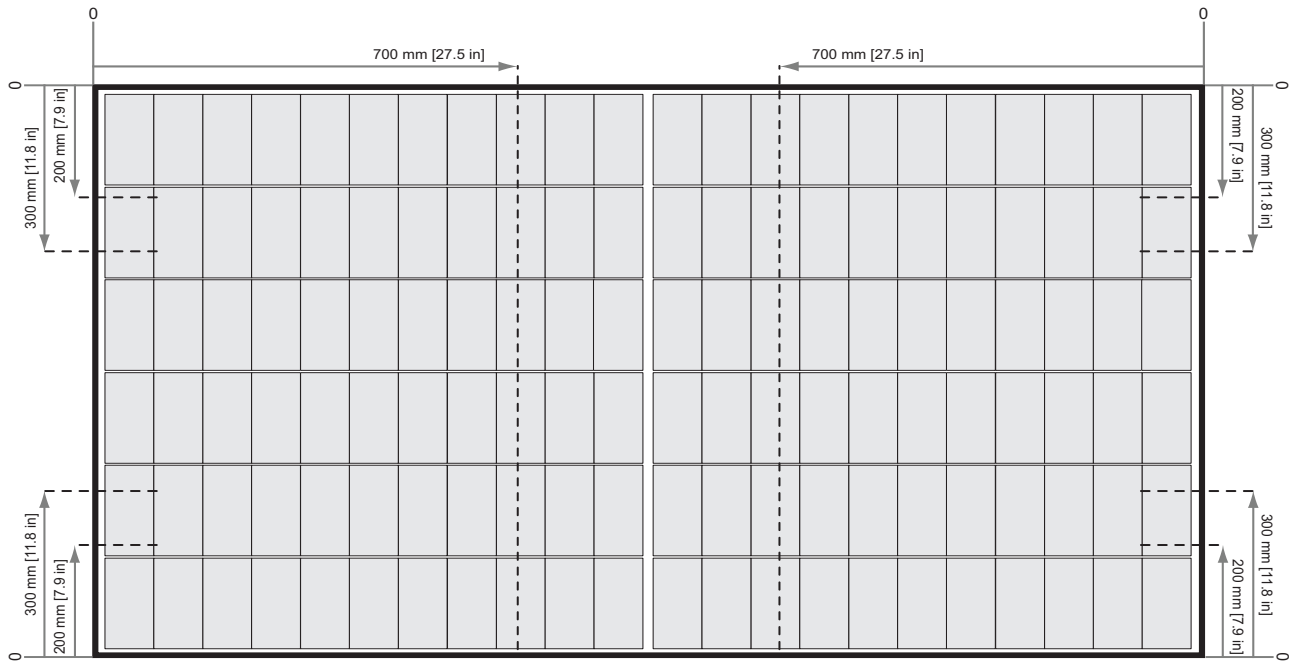
Fig. 7: Clamping of REC Alpha Pure Series panels with rails parallel to long side of the panel

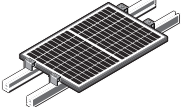

Legend	Clearance Gap		0.8 - 1.6 in (20-40 mm)	1.6 - 2.4 in (40-60 mm)	>2.4 in (>60 mm)	<0.8 in (<20 mm)
			Test Load (Design Load)	Test Load (Design Load)	Test Load (Design Load)	Test Load (Design Load)
 Long Side Mounting	Clamping zone	0 - 27.5 in (0 - 700 mm)	+1200 Pa / -1200 Pa* (+800Pa/-800Pa)	+3000 Pa / -2400 Pa (+2400Pa/-1600Pa)	+5400 Pa / -2400 Pa (+3600Pa/-1600Pa)	X
		 Short Side Mounting	0 - 7.9 in (0 - 200 mm)	X	+1200 Pa / -1200 Pa* (+800Pa/-800Pa)	+1600 Pa / -1600 Pa* (+1066Pa/-1066Pa)
			7.9 - 11.8 in (200 - 300 mm)	X	+800 Pa / -800 Pa* (+533Pa/-533Pa)	+2400 Pa / -2400 Pa (+1600Pa/-1600Pa)
		Once a module is secured in each of the 4 zones (fig. 2), additional clamps, i.e., >5, may be freely located on panel frame without affecting the warranty. Loads marked with a * were not certified as part of IEC 61215/61730 testing; these have been evaluated by REC's internal testing process.				

CAUTION



The center point of each clamp and the minimum grip length must be fully located in the same clamping zones to be rated to that load (fig. 7). If the panel is secured in zones with different load values, it is rated to the lowest load value only.

MOUNTING REC ALPHA PURE SERIES PANELS WITH SHORT RAILS

A short rail (or other short support structure) has a minimum length of 25 mm and does not span the complete underside of a panel.

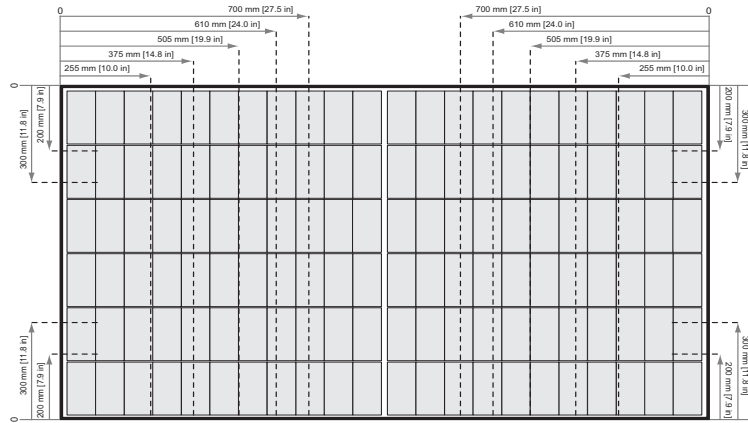
Fig. 8: Clamping of REC Alpha Pure Series panels using short rails

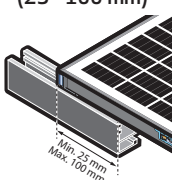
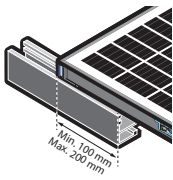

Legend	Clearance Gap		0.8 - 1.6 in (20-40 mm)	1.6 - 2.4 in (40-60 mm)	>2.4 in (>60 mm)	<0.8 in (<20 mm)
			Test Load (Design Load)	Test Load (Design Load)	Test Load (Design Load)	Test Load (Design Load)
Rail length under module 1 - 3.9 in (25 - 100 mm) 	Long Side Mounting	0 - 10.0 in (0 - 255 mm)	X	+1200 Pa / -1200 Pa* (+800Pa/-800Pa)	+1600 Pa / -1600 Pa* (+1066Pa/-1066Pa)	X
		10.0 - 14.8 in (255 - 375 mm)	+1200 Pa / -1200 Pa* (+800Pa/-800Pa)	+4100 Pa / -2400 Pa (+2733Pa/-1600Pa)	+4500 Pa / -2400 Pa (+3000Pa/-1600Pa)	X
		14.8 - 19.9 in (375 - 505 mm)	+1200 Pa / -1200 Pa* (+800Pa/-800Pa)	+3000 Pa / -3000 Pa (+2000Pa/-2000Pa)	+4200 Pa / -4000 Pa (+2800Pa/-2666Pa)	X
		19.9 - 24.0 in (505 - 610 mm)	+1200 Pa / -1200 Pa* (+800Pa/-800Pa)	+2400 Pa / -2400 Pa (+1600Pa/-1600Pa)	+3600 Pa / -2400 Pa (+2400Pa/-1600Pa)	X
		24.0 - 27.5 in (610 - 700 mm)	+1800 Pa / -1800 Pa* (+1200Pa/-1200Pa)	+2400 Pa / -2400 Pa (+1600Pa/-1600Pa)	+2400 Pa / -2400 Pa (+1600Pa/-1600Pa)	X
	Short Side Mounting	0 - 7.9 in (0 - 200 mm)	X	+1200 Pa / -1200 Pa* (+800Pa/-800Pa)	+1600 Pa / -1600 Pa* (+1066Pa/-1066Pa)	X
		7.9 - 11.8 in (200 - 300 mm)	X	+800 Pa / -800 Pa* (+533Pa/-533Pa)	+2400 Pa / -2400 Pa (+1600Pa/-1600Pa)	X
Rail length under module 3.9 - 7.9 in (100 - 200 mm) 	Long Side Mounting	0 - 10.0 in (0 - 255 mm)	X	+1200 Pa / -1200 Pa* (+800Pa/-800Pa)	+1600 Pa / -1600 Pa* (+1066Pa/-1066Pa)	X
		10.0 - 14.8 in (255 - 375 mm)	+1200 Pa / -1200 Pa* (+800Pa/-800Pa)	+3600 Pa / -2400 Pa (+2400Pa/-1600Pa)	+3600 Pa / -2400 Pa (+2400Pa/-1600Pa)	X
		14.8 - 19.9 in (375 - 505 mm)	+1200 Pa / -1200 Pa* (+800Pa/-800Pa)	+3000 Pa / -3000 Pa (+2000Pa/-2000Pa)	+3000 Pa / -3000 Pa (+2000Pa/-2000Pa)	X
		19.9 - 24.0 in (505 - 610 mm)	+1200 Pa / -1200 Pa* (+800Pa/-800Pa)	+2400 Pa / -2400 Pa (+1600Pa/-1600Pa)	+3600 Pa / -2400 Pa (+2400Pa/-1600Pa)	X
		24.0 - 27.5 in (610 - 700 mm)	+1800 Pa / -1800 Pa* (+1200Pa/-1200Pa)	+2400 Pa / -2400 Pa (+1600Pa/-1600Pa)	+2400 Pa / -2400 Pa (+1600Pa/-1600Pa)	X
	Short Side Mounting	0 - 7.9 in (0 - 200 mm)	X	+1200 Pa / -1200 Pa* (+800Pa/-800Pa)	+1600 Pa / -1600 Pa* (+1066Pa/-1066Pa)	X
		7.9 - 11.8 in (200 - 300 mm)	X	+800 Pa / -800 Pa* (+533Pa/-533Pa)	+2400 Pa / -2400 Pa (+1600Pa/-1600Pa)	X
	Once a module is secured in each of the 4 zones (fig. 2), additional clamps, i.e., ≥5, may be freely located on panel frame without affecting the warranty. Loads marked with a * were not certified as part of IEC 61215/61730 testing; these have been evaluated by REC's internal testing process.					

CAUTION
 The center point of each clamp and the minimum grip length must be fully located in the same clamping zones to be rated to that load (fig. 8). If the panel is secured in zones with different load values, it is rated to the lowest load value only.



INSTALLATION OF REC ALPHA 72 SERIES PANELS

MOUNTING REC ALPHA 72 SERIES PANELS WITH CONTINUOUS RAILS PARALLEL TO SHORT SIDE OF THE PANEL

A continuous rail (or other support structure) spans the complete underside of the panel.

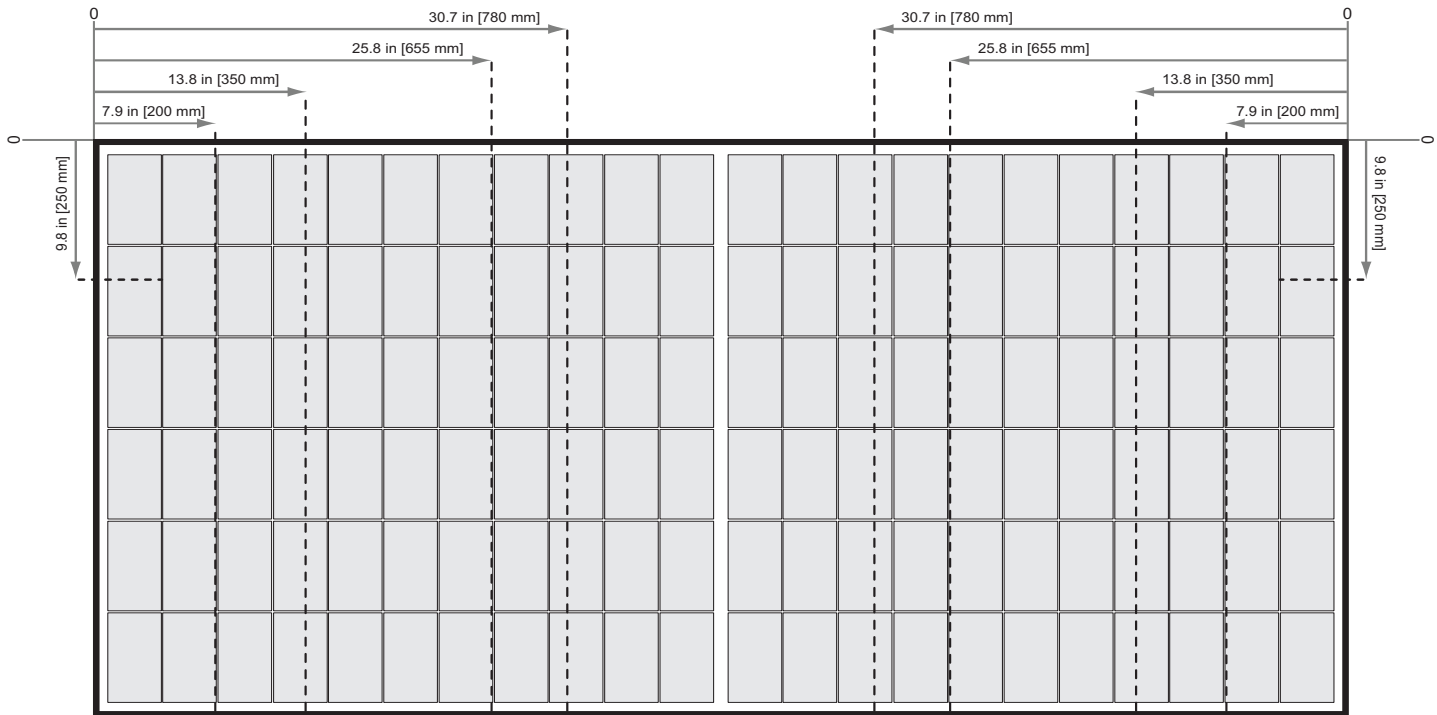
Fig. 9: Clamping of REC Alpha 72 Series panels with rails parallel to short side of the panel

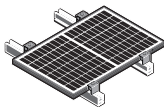
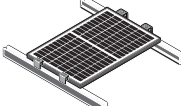

Legend	Clearance Gap		>2.4 in (>60 mm)	>3.3 in (>85 mm)
	Clamping zone		Test Load (Design Load)	Test Load (Design Load)
 Rail position Long Side Mounting	0 - 7.9 in (0 - 200 mm)		+1000 Pa / -1000 Pa* (+667 Pa / -667 Pa)	+1400 Pa / -1400 Pa* (+933 Pa / -933 Pa)
	7.9 - 13.8 in (200 - 350 mm)		+2400 Pa / -2400 Pa (+1600 Pa / -1600 Pa)	+2400 Pa / -2400 Pa (+1600 Pa / -1600 Pa)
	13.8 - 25.8 in (350 - 655 mm)		+5400 Pa / -2400 Pa (+3600 Pa / -1600 Pa)	+5400 Pa / -2400 Pa (+3600 Pa / -1600 Pa)
	25.8 - 30.7 in (655 - 780 mm)		+2400 Pa / -2400 Pa (+1600 Pa / -1600 Pa)	+2400 Pa / -2400 Pa (+1600 Pa / -1600 Pa)
 Rail position Short Side Mounting	0 - 9.8 in (0 - 250 mm)		+1000 Pa / -1000 Pa* (+667 Pa / -667 Pa)	+1400 Pa / -1400 Pa* (+933 Pa / -933 Pa)
		Once a module is secured in each of the 4 zones (fig. 2), additional clamps, i.e., ≥ 5 , may be freely located on panel frame without affecting the warranty. Loads marked with a * were not certified as part of IEC 61215/UL 61730 testing; these have been evaluated by REC's internal testing process.		

CAUTION

The center point of each clamp and the minimum grip length must be fully located in the same clamping zones to be rated to that load (fig. 9). If the panel is secured in zones with different load values, it is rated to the lowest load value only.

MOUNTING REC ALPHA 72 SERIES PANELS WITH SHORT RAILS PARALLEL TO SHORT SIDE OF THE PANEL

A short rail (or other short support structure) has a minimum length of 25 mm and does not span the complete underside of a panel.

Fig. 10: Clamping of REC Alpha 72 Series panels using short rails

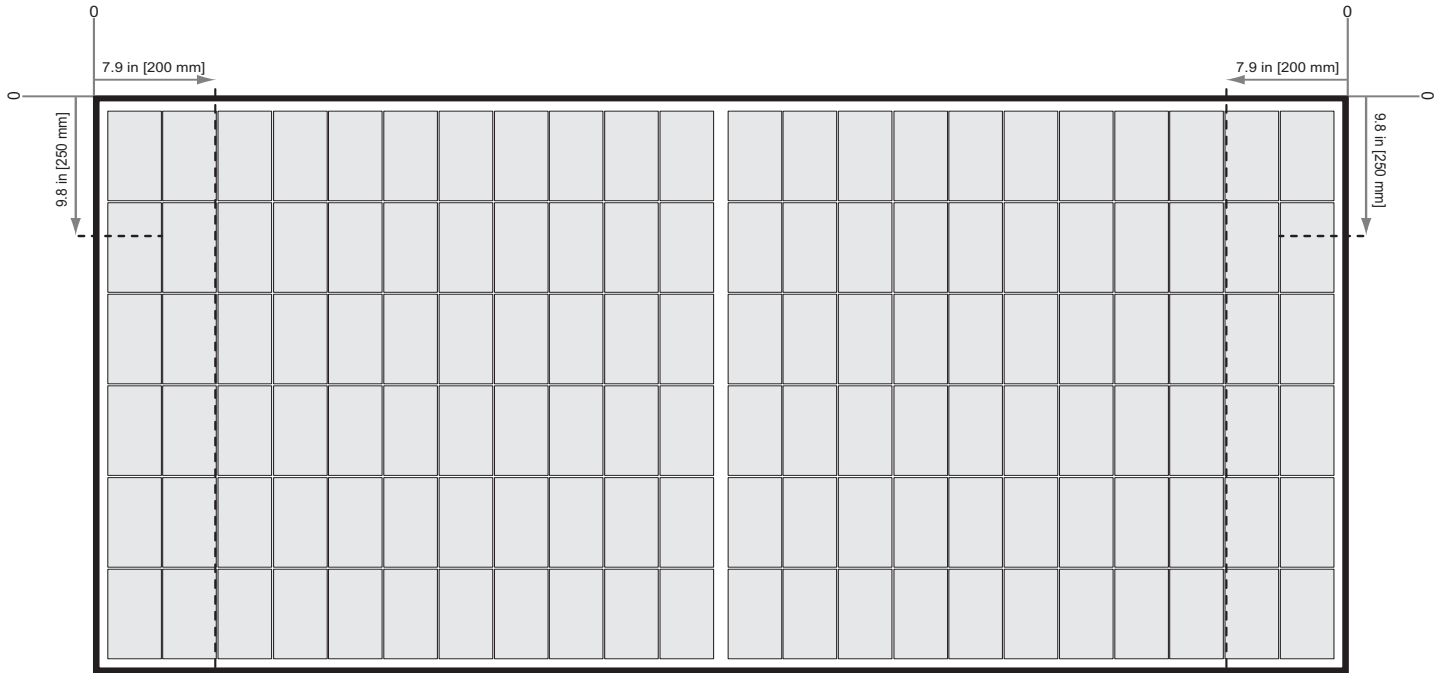

Legend	Clearance Gap		2.4 - 3.3 in (60-85 mm)	>3.3 in (>85 mm)
	Clamping zone		Test Load (Design Load)	Test Load (Design Load)
Rail length under module 1 - 7.9 in (25 - 200 mm)	Long Side Mounting	0 - 7.9 in (0 - 200 mm)	+1000 Pa / -1000 Pa* (+667 Pa / -667 Pa)	+1400 Pa / -1400 Pa* (+933 Pa / -933 Pa)
	Short Side Mounting	0 - 9.8 in (0 - 250 mm)	+1000 Pa / -1000 Pa* (+667 Pa / -667 Pa)	+1400 Pa / -1400 Pa* (+933 Pa / -933 Pa)
	Once a module is secured in each of the 4 zones (fig. 2), additional clamps, i.e., ≥5, may be freely located on panel frame without affecting the warranty. Loads marked with a * were not certified as part of IEC 61215/UL 61730 testing; these have been evaluated by REC's internal testing process.			

CAUTION

The center point of each clamp and the minimum grip length must be fully located in the same clamping zones to be rated to that load (fig. 10). If the panel is secured in zones with different load values, it is rated to the lowest load value only.

MOUNTING METHODS: SLIDE IN SYSTEMS

When installing using slide in systems the mounting system must meet the same specifications including grip lengths, depths and spacing as specified for clamping and the mounting system must be able to withstand the correct load pressures.

When installing solar panels using a slide-in system, the drainage holes found in the underside of the panel frame (see fig. 15) must not be covered. For any questions regarding installation on such systems, please contact REC directly.

MOUNTING METHODS: MOUNTING HOLES

The REC solar panels covered by this manual can be installed utilizing the four mounting holes (11 x 6.6 mm) on the underside of the panel (fig. 11 & 12) in conjunction with a device, e.g., screws, lockbolts or structural blind fasteners, with specifications suitable for the installation (fig. 13).

Installing the REC Alpha & Alpha 72 Series solar panels using the mounting holes has been found to comply with IEC 61215 & UL 61730 requirements for downward pressure, e.g., snow, of up to 5400 Pa (3600 Pa design load*) and upward pressure, e.g., wind, of up to 2400 Pa (1600 Pa design load*) according to the following instructions (*design loads apply a safety factor of 1.5 to the stated test load, e.g., test load 5400 Pa / 1.5 = 3600 Pa design load).

⚠ CAUTION
The product warranty will be voided if additional holes are made in the frame. All fixing and fastening materials must be corrosion resistant.

Fig. 11: Mounting holes: REC Alpha Series

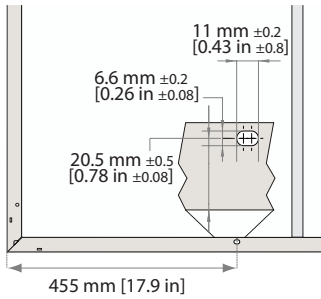

Fig. 12: Mounting holes: REC Alpha 72 Series

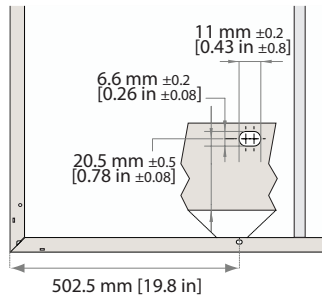

Fig. 13: Device specifications for mounting holes

Part Name	Specification	Material
Rail		6105 - T5 aluminum extrusion
Bolt	1/4" x 20 - 5/8"	ASTM F593 (stainless steel)
Nut	1/4" x 20	ASTM F593 (stainless steel)
Washer	Thickness: ≥ 0.06" Diameter: ≥ 0.7"	

When installing using mounting holes, the frame and panel edge of each panel must be supported by two rails of aluminium or galvanized steel suitable for the application and appropriate for the local environment. Observe the following procedures when using mounting holes:

- The mounting construction must be of a corrosion resistant material, e.g., aluminum or galvanized steel, and appropriate for the local environment,
- All four mounting holes in the frame must be used (fig. 14),
- A washer must be used between frame and rail,
- Additional electrical bonding to Ground is required for the support structure,
- REC modules must be secured with a torque between 12 - 25 Nm (106-221 lbf/in). Refer to the fixing device manufacturer's installation instructions for preload or torque values.

Fig. 14: Mounting hole installation example

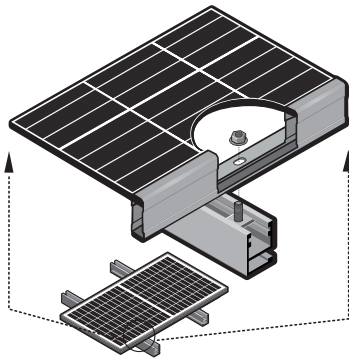

DRAINAGE HOLES

On the long and short sides of the REC frame small drainage holes can be found that allow humidity and water to exit the frame easily and minimize damage (fig. 15). These are spaced 55 mm from the corner on 60/66-cell format panels and 60 mm on 72-cell format panels. These holes must not be used for mounting the panel, and they must not be covered by any part of the mounting structure. To enable effective drainage and ensure there is no damage to the panel, the drainage holes must remain fully open and enable water egress during and after installation. The shape and dimensions of the drainage holes may vary depending on product and/or frame design.

Fig. 15: Drainage and grounding holes

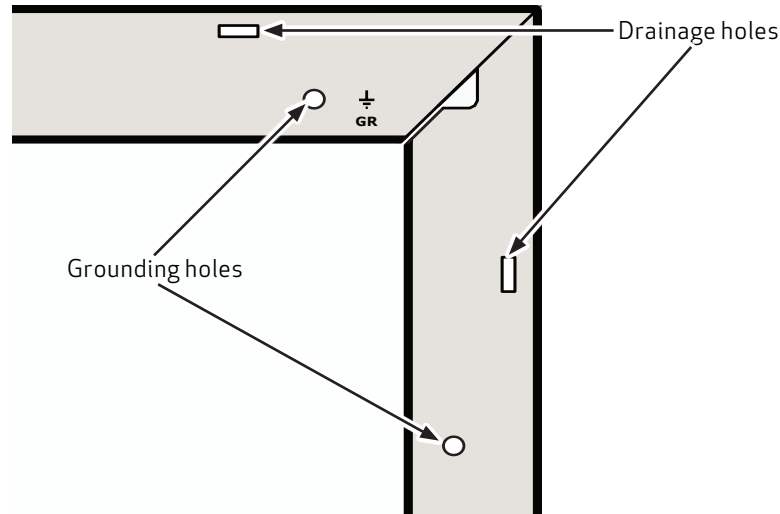

GROUNDING

A panel with exposed conductive parts is considered to be in compliance with IEC 61215 & UL 61730 only when it is electrically grounded in accordance with the instructions presented below and the requirements of the National Electrical Code. When grounding a panel, it must be done using an electrical connection from the panel frame. Local regulations may require grounding of the panels. Grounding must be done using an electrical connection from the panel frame. REC solar panels have a clearly marked, small round $\varnothing 6$ mm grounding hole positioned near each corner of the panel on both the long side and the short side, as shown in fig. 15 and can be further identified by the grounding symbol stamped in the frame next to it. Check all applicable requirements before beginning installation:

- Suitable grounding lugs must be used: Listed (KDER) ILSCO, GBL-4DBT (tin plated) (E34440),
- Grounding cable size should be between 4 - 14 AWG (2.1 mm² - 21.2 mm²),
- Attach grounds to the grounding holes in the panel frames,
- Fix lug to the frame using a star washer (#10) and lock nut (#10), ensuring a conductive connection,
- Follow the grounding device manufacturer's installation instructions to ensure a safe and conductive connection, including any supplementary hardware, e.g., star washer, and tighten according to recommended torque.

Fig. 16: Grounding lug dimensions and fastening torque

Cross section [AWG]	Type	Torque [in-lbs]
4 - 6	Stranded	35
8	Stranded	25
10 - 14	Stranded/Solid	28

i NOTE

- To avoid galvanic corrosion, galvanized or hot dipped zinc plated fasteners are preferred, however stainless steel fastening materials are equally suitable.
- The support bars across the rear of REC Alpha Series panels are connected to the frame via specially designed grounding clips and do not need to be individually grounded.
- Negative grounding of the panels is not required by REC.

CONNECTIONS AND CONNECTORS

The connector type(s) used on REC panels are indicated in the product specifications at the rear of this manual. The connector IP rating is only valid when correctly connected. All connectors and cables must be secure and tight as well as electrically and mechanically sound. UV-resistant cables and connectors approved for outdoor use must be used. Conductor gauge must be chosen to ensure DC power losses (voltage drop) are kept to a minimum (<1%).

Observe all local regulations when selecting cables.

- For string connections, use minimum 12 AWG (4 mm²) copper wires insulated for a maximum operating temperature of 194°F (90°C),
- Avoid exposing cables to direct sunlight and permanent tension.

In order to ensure a safe connection between panels and BOS equipment, the following instructions must be followed to protect the connections from the elements.

⚠ DANGER - Electrical shock

Safety is paramount when working with electrical connectors.

- Ensure that any installation work is not carried out on live or load-carrying parts.
- Connections must not be disconnected under load and the system must be isolated from the grid before carrying out any maintenance or repair work.

CONNECTORS

To ensure connector compatibility and reduce the potential for damage to the panels and the wider installation, the connectors used on REC Alpha panels are detailed in the Panel Characteristics at the rear of this manual. REC only permits the mating of connectors of the same manufacturer, type, and system rating.

i NOTE

Some countries and/or regions have specific regulations regarding the mating of connectors. Installers are responsible for ensuring the compliancy of the system with such local regulations.

CUTTING THE CABLES

The cutting of cables is only permitted in order to replace a factory-installed connector with another brand of connector to ensure 'like-for-like' mating when connected to a non-REC external device. All other changes are prohibited and will invalidate the REC warranty.

- The connector replacement procedure must be carried out correctly and according to the replacement connector manufacturer's instructions.
- The selected replacement connector must also fulfil all relevant technical specifications and be certified according to applicable standards (e.g., EN 50521, IEC 62852 or UL 6703) to ensure they are fit for purpose and safety.
- Use of any chemicals or lubricants on the connectors or contacts may only be carried out in line with the connector manufacturer's instructions.

The REC warranty does not extend to cover any fault traceable to the replaced connectors. Any other modification to the panel is prohibited, including the opening of the junction box, unless explicitly authorized by REC. Doing so will invalidate the warranty.

CABLE MANAGEMENT

To ensure a long life span of the cables and reduce the potential for damage to the cables, follow the instructions below:

- To prevent stress on the junction box casing, ensure the cable exits the junction box in a straight line before any bend in the cable and ensure cables are free from any external load,
- The cables must have a minimum bending radius of 1.2 in (30 mm) to avoid damage to the insulation (fig. 17),
- Ensure cables do not hang loose where they may be damaged through friction or stress, e.g., caused by mechanical abrasion or grazing animals,
- Protect connectors from falling or dropping water by locating them directly beneath a panel,
- Cables must be firmly secured to the structure, without over-tightening, as this can deform the cable insulation using UV-resistant cables,
- When securing the connector, place it so that it has with sufficient air circulation all around. This allows the connector to dry effectively and avoids the risk of damage or degradation of the connection,
- Secure the cable either side of the connectors to ensure no stress is exerted on the connector casing or cable entry,
- To enable correct cooling and drying of the connectors, do not add extra protection to the connector, e.g., heat shrink, grease or tape.

More detailed information is given in the *Guide to Best Practice - Connections and Connectors* which can be found via the REC online Download Center (www.recgroup.com/downloads)

Fig. 17: Minimum cable bend radius

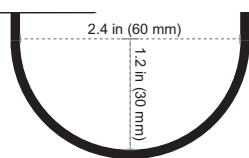

PANEL MAINTENANCE

CLEANING INSTRUCTIONS

REC solar panels have been designed for easy maintenance. However cleaning solar panels can assist in optimizing electricity output. The need for cleaning will vary dependent on location, rainfall, pollution levels and the angle of installation – the lower the angle of installation, the more cleaning will be required. 'Normal' rainfall will naturally clean the panels if installed at a sufficient angle to ensure water runs off the surface. To optimize electrical output it is recommended to clean the panels when dirt can clearly be seen on the glass surface.

CAUTION

- Panel cleaning must always be carried out when the panels are cool, e.g., early morning, to avoid breakage through thermal shock.
- Use of high pressure hoses or cleaners is not permitted as these may damage the panels, laminate or cells.

NOTE

- Avoid putting pressure on the on the panel surface when cleaning or drying, e.g., leaning, standing or resting buckets on it.
- Use only deionized water free from grit and physical contaminants, at ambient temperature and use a sponge, microfiber cloth or a soft brush to wipe away the dirt (rainwater, tap water or diluted alcohol may also be used as a secondary solution).
- For further cleaning a mild, biological and biodegradable washing-up liquid may be used.
- If stains require more effort to be removed, Isopropyl alcohol of a concentration less than 10% may be used. Acidic or alkaline detergent may not be used.

Using a soft rubber squeegee, wipe the panel surface from the top downwards to remove any residual water from the panel glass. Take care not to scratch the surface or introduce foreign elements that may cause damage to the panel. Always rinse the panel with plenty of water. Panels can be left to dry in the air or wiped dry with a clean and soft cloth or chamois.

For more information on cleaning REC solar panels, consult the *REC Cleaning Information Sheet* which is available to download from the online REC Download Center www.recgroup.com/downloads. If in doubt at any time when cleaning the panels, stop and obtain professional advice.

SYSTEM INSPECTION

The system should be inspected regularly to ensure that:

- Fasteners are secure, tight and free from corrosion,
- Electrical connections are secure, tight, clean and free of corrosion,
- The mechanical integrity of the cables is intact,
- Bonding points to ground are tight, secure and free from corrosion (which could break the continuity between the panels and ground).

RECYCLING

REC makes every effort to ensure panel packaging is kept to a minimum. The paper and cardboard packaging can be recycled and the protective wrapping and panel separating blocks are also recyclable in many areas. Recycle packaging and panels according to local guidelines and regulations.

DISPOSAL OF OLD ELECTRICAL AND ELECTRONIC EQUIPMENT

Panels should be recycled at the end of their useful life according to local guidelines and regulations. By ensuring REC solar panels are disposed of correctly, you will help prevent potential negative consequences for the environment and human health which could otherwise be caused by inappropriate waste treatment. The majority of the panel components can be recycled.

PANEL CHARACTERISTICS

TECHNICAL PROPERTIES: REC ALPHA SERIES

Fig. 18: Panel dimensions: REC Alpha Series

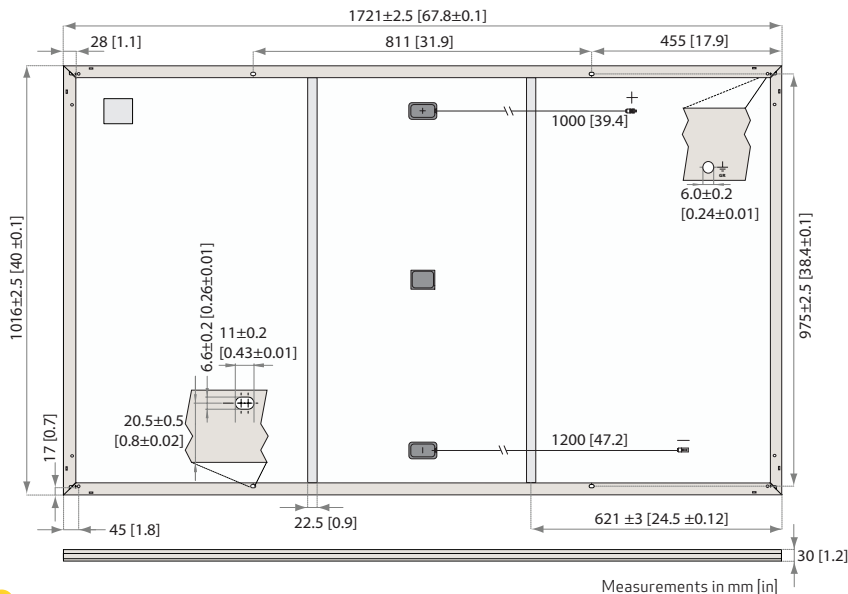

GENERAL DATA

Cell type:	120 half-cut cells with REC heterojunction bifacial cell technology 6 strings of 20 cells in series	Connectors:	Stäubli MC4 PV-KBT4/KST4, 12AWG (4mm ²) in accordance with IEC 62852 IP68 only when connected
Glass:	0.13 in (3.2 mm) solar glass with anti-reflection surface treatment	Cable:	12AWG (4mm ²) PV wire, 39+47 in (1+1.2m) accordance with EN50618
Backsheet:	Highly resistant polymeric construction	Dimensions:	678x40x1.2 in (1721x1016x30 mm)
Frame:	Anodized aluminum (black)	Weight:	43 lbs (19.5 kg)
Junction box:	3-part, 3 bypass diodes, IP68 rated in accordance with IEC 62790	Origin:	Made in Singapore

ELECTRICAL DATA

Product Code*: RECxxxAA

	360	365	370	375	380
Power Output - P _{MAX} (Wp)	360	365	370	375	380
Watt Class Sorting - (W)	-0/+5	-0/+5	-0/+5	-0/+5	-0/+5
Nominal Power Voltage - V _{MPP} (V)	36.7	37.1	37.4	37.8	38.1
Nominal Power Current - I _{MPP} (A)	9.82	9.85	9.90	9.94	9.98
Open Circuit Voltage - V _{OC} (V)	43.9	44.0	44.1	44.2	44.3
Short Circuit Current - I _{SC} (A)	10.49	10.52	10.55	10.58	10.61
Power Density (W/sq ft)	19.1	19.4	19.7	19.9	20.2
Panel Efficiency (%)	20.6	20.9	21.2	21.4	21.7
Power Output - P _{MAX} (Wp)	274	278	282	286	289
Nominal Power Voltage - V _{MPP} (V)	34.6	35.0	35.2	35.6	35.9
Nominal Power Current - I _{MPP} (A)	7.93	7.96	8.00	8.03	8.06
Open Circuit Voltage - V _{OC} (V)	41.4	41.5	41.6	41.6	41.7
Short Circuit Current - I _{SC} (A)	8.47	8.50	8.52	8.55	8.57

Values at standard test conditions (STC: air mass AM1.5, irradiance 10.75 W/sq ft (1000 W/m²), temperature 77°F (25°C), based on a production spread with a tolerance of P_{MAX}, V_{OC} & I_{SC} ±3% within one watt class. Nominal module operating temperature (NMOT: air mass AM1.5, irradiance 800 W/m², temperature 68°F (20°C), windspeed 3.3 ft/s (1 m/s). *Where xxx indicates the nominal power class (P_{MAX}) at STC above.

CERTIFICATIONS

IEC 61215:2016, IEC 61730:2016, UL 61730	
IEC 62804	PID
IEC 61701	Salt Mist
IEC 62716	Ammonia Resistance
UL 1703	Fire Type 2
IEC 62782	Dynamic Mechanical Load
IEC 61215-2:2016	Hailstone (35mm)
AS4040.2 NCC 2016	Cyclic Wind Load
ISO 14001:2004, ISO 9001:2015, OHSAS 18001:2007, IEC 62941	



WARRANTY

	Standard	REC ProTrust	
Installed by an REC Certified Solar Professional	No	Yes	Yes
System Size	All	≤25 kW	25-500 kW
Product Warranty (yrs)	20	25	25
Power Warranty (yrs)	25	25	25
Labor Warranty (yrs)	0	25	10
Power in Year 1	98%	98%	98%
Annual Degradation	0.25%	0.25%	0.25%
Power in Year 25	92%	92%	92%

See warranty documents for details. Conditions apply.

MAXIMUM RATINGS

Operational temperature:	-40 ... +185°F (-40 ... +85°C)
Maximum system voltage:	1000 V
Maximum test load (front):	+7000 Pa (146 lbs/sq ft)*
Maximum test load (rear):	-4000 Pa (83.5 lbs/sq ft)*
Max series fuse rating:	25 A
Max reverse current:	25 A

*See installation manual for mounting instructions.
Design load = Test load / 1.5 (safety factor)

TEMPERATURE RATINGS*

Nominal Module Operating Temperature:	44°C (±2°C)
Temperature coefficient of P _{MAX} :	-0.26 %/°C
Temperature coefficient of V _{OC} :	-0.24 %/°C
Temperature coefficient of I _{SC} :	0.04 %/°C

*The temperature coefficients stated are linear values

LOW LIGHT BEHAVIOUR

Typical low irradiance performance of module at STC:

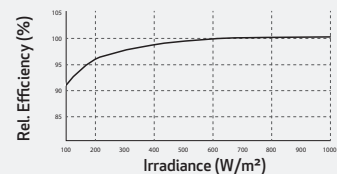

Specifications subject to change without notice.

Ref: PM-DS-12-01-Rev- F 01/21

TECHNICAL PROPERTIES: REC ALPHA BLACK SERIES

Fig. 19: Panel dimensions: REC Alpha Black Series

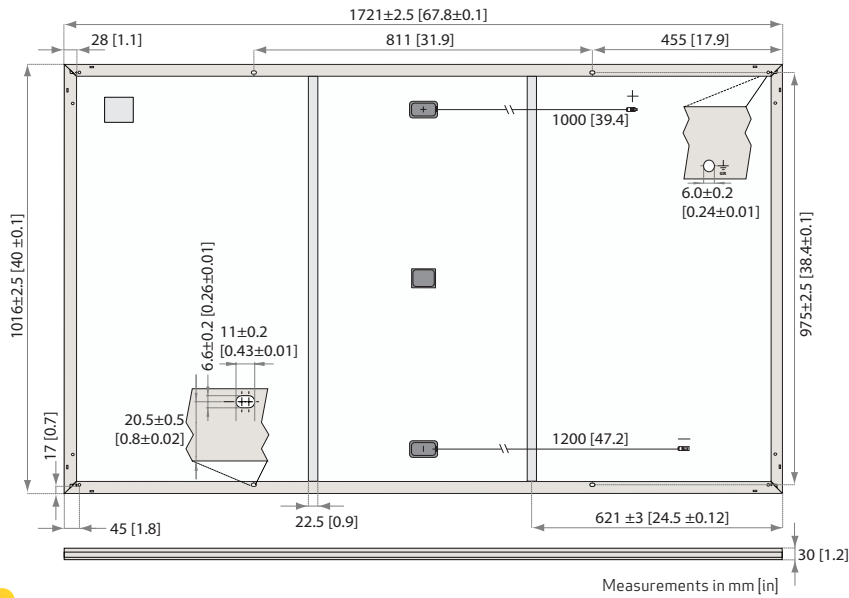

Measurements in mm [in]

GENERAL DATA

Cell type:	120 half-cut cells with REC heterojunction bifacial cell technology 6 strings of 20 cells in series	Connectors:	Stäubli MC4 PV-KBT4/KST4, 12AWG (4mm ²) in accordance with IEC 62852 IP68 only when connected
Glass:	0.13 in (3.2 mm) solar glass with anti-reflection surface treatment	Cable:	12AWG (4mm ²) PV wire, 39+47 in (1+1.2m) in accordance with EN 50618
Backsheet:	Highly resistant polymeric construction (black)	Dimensions:	67.8x40x1.2 in (1721x1016x30 mm)
Frame:	Anodized aluminum (black)	Weight:	43 lbs (19.5 kg)
Junction box:	3-part, 3 bypass diodes, IP68 rated in accordance with IEC 62790	Origin:	Made in Singapore

ELECTRICAL DATA

Product Code*: RECxxxAA Black

	355	360	365	370	375
Power Output - P _{MAX} (Wp)	355	360	365	370	375
Watt Class Sorting - (W)	-0/+5	-0/+5	-0/+5	-0/+5	-0/+5
Nominal Power Voltage - V _{MPP} (V)	36.4	36.7	37.1	37.4	37.8
Nominal Power Current - I _{MPP} (A)	9.77	9.82	9.85	9.90	9.94
Open Circuit Voltage - V _{OC} (V)	43.6	43.9	44.0	44.1	44.2
Short Circuit Current - I _{SC} (A)	10.47	10.49	10.52	10.55	10.58
Power Density (W/sq ft)	18.9	19.1	19.4	19.7	19.9
Panel Efficiency (%)	20.3	20.6	20.9	21.2	21.4
Power Output - P _{MAX} (Wp)	271	274	278	282	286
Nominal Power Voltage - V _{MPP} (V)	34.3	34.6	35.0	35.2	35.6
Nominal Power Current - I _{MPP} (A)	7.89	7.93	7.96	8.00	8.03
Open Circuit Voltage - V _{OC} (V)	41.1	41.4	41.5	41.6	41.6
Short Circuit Current - I _{SC} (A)	8.46	8.47	8.50	8.52	8.55

Values at standard test conditions (STC: air mass AM1.5, irradiance 10.75 W/sq ft (1000 W/m²), temperature 77°F (25°C), based on a production spread with a tolerance of P_{MAX}, V_{OC} & I_{SC} ±3% within one watt class. Nominal module operating temperature (NMOT: air mass AM1.5, irradiance 800 W/m², temperature 68°F (20°C), windspeed 3.3 ft/s (1 m/s). *Where xxx indicates the nominal power class (P_{MAX}) at STC above.

CERTIFICATIONS

IEC 61215:2016, IEC 61730:2016, UL 61730	
IEC 62804	PID
IEC 61701	Salt Mist
IEC 62716	Ammonia Resistance
UL 1703	Fire Type 2
IEC 62782	Dynamic Mechanical Load
IEC 61215-2:2016	Hailstone (35mm)
AS4040.2 NCC 2016	Cyclic Wind Load
ISO 14001:2004, ISO 9001:2015, OHSAS 18001:2007, IEC 62941	



WARRANTY

	Standard	REC ProTrust	
		No	Yes
Installed by an REC Certified Solar Professional	No	Yes	Yes
System Size	All	≤25 kW	25-500 kW
Product Warranty (yrs)	20	25	25
Power Warranty (yrs)	25	25	25
Labor Warranty (yrs)	0	25	10
Power in Year 1	98%	98%	98%
Annual Degradation	0.25%	0.25%	0.25%
Power in Year 25	92%	92%	92%

See warranty documents for details. Conditions apply.

MAXIMUM RATINGS

Operational temperature:	-40 ... +185°F (-40 ... +85°C)
Maximum system voltage:	1000 V
Maximum test load (front):	+7000 Pa (146 lbs/sq ft)*
Maximum test load (rear):	-4000 Pa (83.5 lbs/sq ft)*
Max series fuse rating:	25 A
Max reverse current:	25 A

*See installation manual for mounting instructions. Design load = Test load / 1.5 (safety factor)

TEMPERATURE RATINGS*

Nominal Module Operating Temperature:	44°C (±2°C)
Temperature coefficient of P _{MAX} :	-0.26 %/°C
Temperature coefficient of V _{OC} :	-0.24 %/°C
Temperature coefficient of I _{SC} :	0.04 %/°C

*The temperature coefficients stated are linear values

LOW LIGHT BEHAVIOUR

Typical low irradiance performance of module at STC:

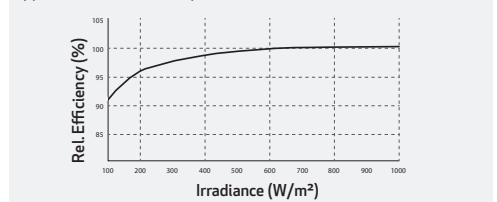

Specifications subject to change without notice.

Ref: PM-DS-12-02-Rev-F-01.21

TECHNICAL PROPERTIES: REC ALPHA PURE SERIES

Fig. 20: Panel dimensions: REC Alpha Pure Series

GENERAL DATA	
Cell type:	132 half-cut REC heterojunction bifacial cells with lead-free, gapless technology, 6 strings of 22 cells in series
Glass:	0.13in(3.2mm) solar glass with anti-reflective surface treatment in accordance with EN 12150
Backsheet:	Highly resistant polymer (black)
Frame:	Anodized aluminum (black)
Junction box:	3-part, 3 bypass diodes, lead-free IP68 rated, in accordance with IEC 62790
Connectors:	Stäubli MC4 PV-KBT4/KST4 (4 mm ²) in accordance with IEC 62852, IP68 only when connected
Cable:	12 AWG (4 mm ²) PV wire, 43+ 47 in (1.1+ 1.2 m) in accordance with EN 50618
Dimensions:	71.7 x 40 x 1.2 in (19.91 ft ²) / 1821 x 1016 x 30 mm (1.85 m ²)
Weight:	45 lbs (20.5 kg)
Origin:	Made in Singapore

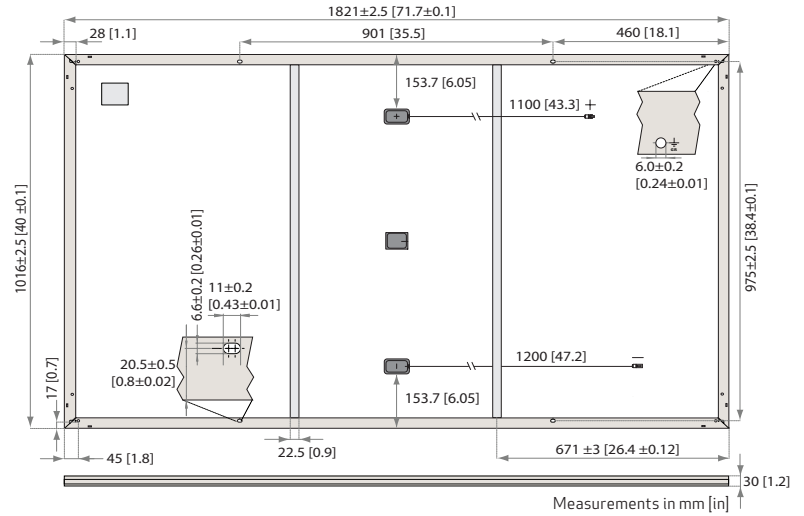

	ELECTRICAL DATA							Product Code*: RECxxxAA Pure								
STC	Power Output - P _{MAX} (Wp)	380	385	390	395	400	405	410								
	Watt Class Sorting - (W)	0/+5	0/+5	0/+5	0/+5	0/+5	0/+5	0/+5								
	Nominal Power Voltage - V _{MPP} (V)	40.9	41.2	41.5	41.8	42.1	42.4	42.7								
	Nominal Power Current - I _{MPP} (A)	9.30	9.35	9.40	9.45	9.51	9.56	9.61								
	Open Circuit Voltage - V _{OC} (V)	48.4	48.5	48.6	48.7	48.8	48.9	49.0								
	Short Circuit Current - I _{SC} (A)	10.17	10.18	10.22	10.25	10.28	10.30	10.35								
	Power Density (W/ft ²)	19.1	19.3	19.6	19.8	20.1	20.3	20.6								
NMOT	Panel Efficiency (%)	20.5	20.8	21.1	21.4	21.6	21.9	22.2								
	Power Output - P _{MAX} (Wp)	290	293	297	301	305	309	312								
	Nominal Power Voltage - V _{MPP} (V)	38.5	38.8	39.1	39.4	39.7	40.0	40.2								
	Nominal Power Current - I _{MPP} (A)	7.51	7.55	7.59	7.63	7.68	7.72	7.76								
	Open Circuit Voltage - V _{OC} (V)	45.6	45.7	45.8	45.9	46.0	46.1	46.2								
	Short Circuit Current - I _{SC} (A)	8.12	8.16	8.20	8.24	8.28	8.32	8.36								

Values at standard test conditions (STC: air mass AM1.5, irradiance 10.75 W/sq ft (1000 W/m²), temperature 77°F (25°C), based on a production spread with a tolerance of P_{MAX}, V_{OC} & I_{SC} ±3% within one watt class. Nominal module operating temperature (NMOT: air mass AM1.5, irradiance 800 W/m², temperature 68°F (20°C), windspeed 3.3 ft/s (1 m/s). *Where xxx indicates the nominal power class (P_{MAX}) at STC above.

MAXIMUM RATINGS	
Operational temperature:	-40 ... +85°C
Maximum system voltage:	1000 V
Maximum test load (front):	+ 7000 Pa (146 lbs/ft ²)*
Maximum test load (rear):	- 4000 Pa (83.5 lbs/ft ²)*
Max series fuse rating:	25 A
Max reverse current:	25 A

* See installation manual for mounting instructions.
Design load = Test load / 1.5 (safety factor)

	WARRANTY		
	Standard	REC ProTrust	
Installed by an REC Certified Solar Professional	No	Yes	Yes
System Size	All	≤25 kW	25-500 kW
Product Warranty (yrs)	20	25	25
Power Warranty (yrs)	25	25	25
Labor Warranty (yrs)	0	25	10
Power in Year 1	98%	98%	98%
Annual Degradation	0.25%	0.25%	0.25%
Power in Year 25	92%	92%	92%

See warranty documents for details. Conditions apply

CERTIFICATIONS	
IEC 61215:2016, IEC 61730:2016, UL 61730	
IEC 62804	PID
IEC 61701	Salt Mist
IEC 62716	Ammonia Resistance
UL 61730	Fire Type Class 2
IEC 62782	Dynamic Mechanical Load
IEC 61215-2:2016	Hailstone (35mm)
IEC 62321	Lead-free acc. to RoHS EU 863/2015
ISO 14001, ISO 9001, IEC 45001, IEC 62941	



TEMPERATURE RATINGS*	
Nominal Module Operating Temperature:	44°C (±2°C)
Temperature coefficient of P _{MAX} :	-0.26%/°C
Temperature coefficient of V _{OC} :	-0.24%/°C
Temperature coefficient of I _{SC} :	0.04%/°C

*The temperature coefficients stated are linear values

DELIVERY INFORMATION	
Panels per pallet:	33
Panels per 40 ft GP/high cube container:	792 (24 pallets)
Panels per 53 ft truck:	891 (27 pallets)

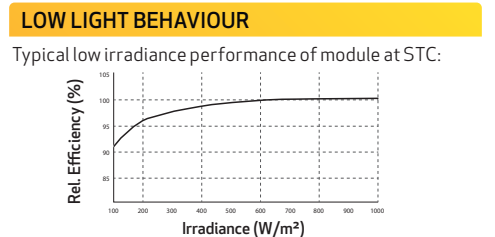

TECHNICAL PROPERTIES: REC ALPHA 72 SERIES

Fig. 21: Panel dimensions: REC Alpha 72 Series

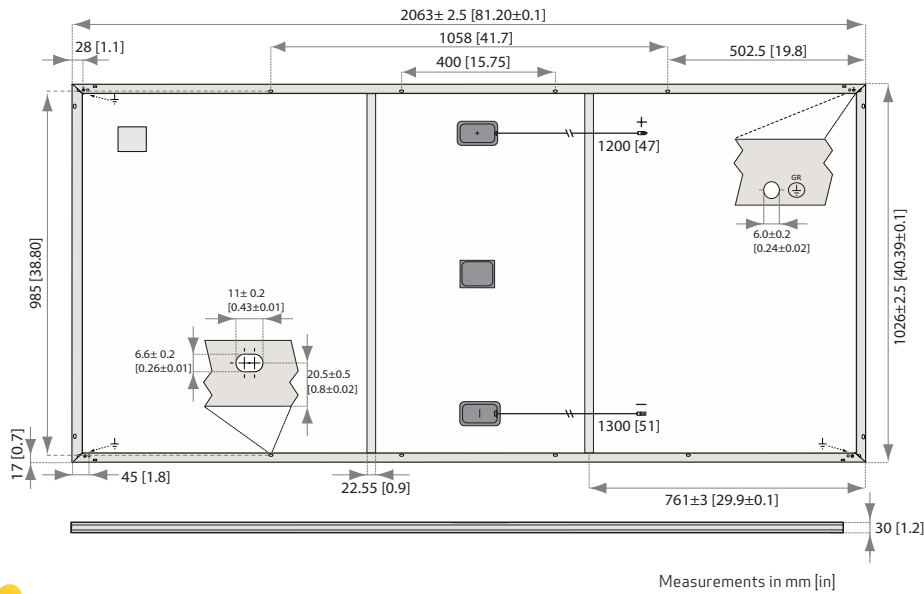

GENERAL DATA

Cell type:	144 half-cut cells with REC heterojunction bifacial cell technology 6 strings of 24 cells in series	Connectors:	Stäubli MC4Evo 2 PV-KBT4-EVO-2/PV-KST4-EVO-2 (4mm ²) in accordance with IEC 62852 IP68 only when connected
Glass:	0.13 in (3.2 mm) solar glass with anti-reflection surface treatment	Cable:	12AWG (4mm ²) PV wire, 47 + 51 in (1.2+1.3m) in accordance with EN 50618
Backsheet:	Highly resistant polymeric construction	Dimensions:	81.2x 40.39x 1.18 in (2063x 1026x 30mm)
Frame:	Anodized aluminum	Weight:	52 lbs (23,5 kg)
Junction box:	3-part, 3 bypass diodes, IP67 rated in accordance with IEC 62790	Origin:	Made in Singapore

ELECTRICAL DATA

Product Code*: RECxxxAA 72

	430	435	440	445	450
Power Output - P _{MAX} (Wp)	430	435	440	445	450
Watt Class Sorting - (W)	-0/+5	-0/+5	-0/+5	-0/+5	-0/+5
Nominal Power Voltage - V _{MPP} (V)	44.1	44.5	44.8	45.3	45.6
Nominal Power Current - I _{MPP} (A)	9.76	9.79	9.84	9.85	9.88
Open Circuit Voltage - V _{OC} (V)	52.6	52.8	52.9	53.0	53.1
Short Circuit Current - I _{SC} (A)	10.46	10.50	10.52	10.54	10.55
Power Density (W/sq ft)	18.9	19.1	19.3	19.5	19.8
Panel Efficiency (%)	20.3	20.6	20.8	21.0	21.3
Power Output - P _{MAX} (Wp)	328	332	336	339	343
Nominal Power Voltage - V _{MPP} (V)	41.6	41.9	42.2	42.7	43.0
Nominal Power Current - I _{MPP} (A)	7.88	7.91	7.95	7.95	7.98
Open Circuit Voltage - V _{OC} (V)	49.6	49.8	49.8	49.9	50.0
Short Circuit Current - I _{SC} (A)	8.45	8.48	8.50	8.51	8.52

Values at standard test conditions (STC: air mass AM1.5, irradiance 10.75 W/sq ft (1000 W/m²), temperature 77°F (25°C), based on a production spread with a tolerance of P_{MAX}, V_{OC} & I_{SC} +3% within one watt class.

Nominal module operating temperature (NMOT: air mass AM1.5, irradiance 800 W/m², temperature 68°F (20°C), windspeed 3.3 ft/s (1 m/s).

*Where xxx indicates the nominal power class (P_{MAX}) at STC above and is followed by the suffix XV for 1500V rated modules.

CERTIFICATIONS

IEC 61215:2016, IEC 61730:2016, UL 61730	
IEC 62804	PID
IEC 61701	Salt Mist
IEC 62716	Ammonia Resistance
UL 1703	Fire Type 2
IEC 62782	Dynamic Mechanical Load
IEC 61215-2:2016	Hailstone (35mm)
AS4040.2 NCC 2016	Cyclic Wind Load
ISO 14001:2004, ISO 9001:2015, OHSAS 18001:2007, IEC 62941	



WARRANTY

	Standard	REC ProTrust	
Installed by an REC Certified Solar Professional	No	Yes	Yes
System Size	All	<25 kW	25-500 kW
Product Warranty (yrs)	20	25	25
Power Warranty (yrs)	25	25	25
Labor Warranty (yrs)	0	25	10
Power in Year 1	98%	98%	98%
Annual Degradation	0.25%	0.25%	0.25%
Power in Year 25	92%	92%	92%

See warranty documents for details. Conditions apply.

MAXIMUM RATINGS

Operational temperature:	-40 ... +185°F (-40 ... +85°C)
Maximum system voltage:	1500 V
Maximum test load (front):	+ 5400 Pa (112.8 lbs/sq ft)*
Maximum test load (rear):	- 2400 Pa (50.1 lbs/sq ft)*
Max series fuse rating:	25 A
Max reverse current:	25 A

*See installation manual for mounting instructions.
Design load = Test load / 1.5 (safety factor)

TEMPERATURE RATINGS*

Nominal Module Operating Temperature:	44°C (±2°C)
Temperature coefficient of P _{MAX} :	-0.26 %/°C
Temperature coefficient of V _{OC} :	-0.24 %/°C
Temperature coefficient of I _{SC} :	0.04 %/°C

*The temperature coefficients stated are linear values

LOW LIGHT BEHAVIOUR

Typical low irradiance performance of module at STC:

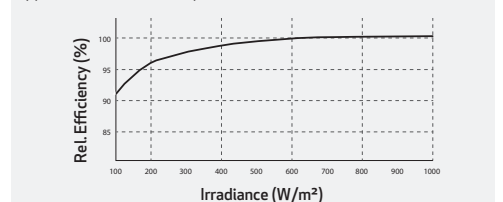

ANNEX 1: INSTALLATIONS ON WATER PLATFORMS

The REC solar panels covered by this manual may be installed on water platform-type mounting systems (note that the certification testing of solar panels does not include testing on these types of systems). When installing REC solar panels on fixed position (e.g., anchored) water platforms, for example, floating pontoons, follow the instructions below specific to such applications. Failure to do so will invalidate the warranty.

i NOTE

For all installations on water platforms, first advise REC before the start of installation in case of any site specific instructions or constraints.

INSTALLATION ENVIRONMENT

i) Installation site

- REC solar panels may only be installed on closed bodies of fresh water where water salinity does not exceed 15 PSU (25 mS/cm) at 77°F (25°C). This specifically excludes mounting on sea and ocean applications.
- The maximum permitted wave height must not exceed 1 m from the crest to the trough of the wave.

ii) Floating platforms

- When using a floating platform, follow the manufacturer's instructions regarding installation, maintenance, inspection and cleaning at all times.

iii) Minimum installation height

- The minimum installation height of REC solar panels on floating platform systems is 6 in (15 cm) and is defined as the height between the water surface and the lowest edge/part of the panel during normal operation. This will help to shield the panel from direct water spray.

INSTALLATION INSTRUCTIONS

i) System installation

- All cables used for the installation must have sufficient length and slack to prevent damage due to water level changes and wave motions.

i NOTE

Negative system grounding is required for REC solar panels installed on a floating platform.

ii) Mounting panels

- Installation of REC solar panels must be in accordance with the aforementioned standard mounting instructions.
- The junction box should be oriented as far as possible from the water surface according to system design and the junction box, cables and connectors must be protected from direct water splash.
- The installation must allow for sufficient spacing between individual panels, in order to avoid all contact as caused by the natural movement and flexing of the floating structure.

iii) Panel protection

- In areas with high avian activity, additional bird repelling devices may be installed as long as they do not adversely affect system performance, e.g., shading or to the local environment etc.
- If using lightning protection equipment on the floating installation, all relevant local regulations must be respected.

MAINTENANCE

- Regularly inspect the installation to ensure all panels are securely mounted.

i NOTE

For installations with high avian activity, system cleaning may be required at more frequent intervals to reduce shading of panels caused by bird defecation.

SAFETY

- Immediately disconnect the system if the installation or the floating platform exhibits deviation from standard operating conditions.
- In the event of the floating platform being submerged, disconnect the DC connection at the inverter immediately. Do not attempt to salvage panels when sunlight is present.

ANNEX 2: INSTALLATIONS USING MODULE LEVEL POWER ELECTRONICS

This section is applicable to all REC products referred to in this installation manual.

Module Level Power Electronics (MLPE) is the name given to the range of panel-level components that can be installed in PV system circuits installed on or in buildings to reduce shock hazard for emergency responders. MLPE devices can be supplied pre-installed by panel manufacturers or as a 'retro-fit' system made by third-party manufacturers. From January 1, 2019, Section 690.12 of the 2017 National Electrical Code (NEC) (in the U.S.A.) requires the panel-level rapid shutdown of solar systems (replacing the previous array-level shutdown requirement of NEC 2014). This means that all conductors within an array's 11.8 in (300 mm) boundary have to be reduced to 80 V or less within 30 seconds of rapid shutdown initiation.



MLPE devices may be used on REC solar panels where desirable or mandatory (note that the certification testing of solar panels does not include testing with MLPE devices). When installing an MLPE device on an REC solar panel, follow the instructions provided by the device manufacturer and the instructions specific for REC solar panels given below. Failure to follow the manufacturer and the REC instructions may invalidate the warranty.

INSTALLATION

i) Installation

- MLPE devices are suitable for use wherever solar panels are suitable for installation. Observe any limitations set by the MLPE manufacturer. (e.g., minimum mounting gap between MLPE and rooftop).
- When attaching an MLPE device to a solar panel, it must be secured to the panel frame. Follow MLPE manufacturer instructions to ensure optimum mounting of MLPE device and prevent any slippage during operation.
- MLPE devices may also be attached to the mounting construction. In such cases, refer to the instructions provided by the manufacturer.
- Wherever possible, the installation of the MLPE device should not cover the product label on the rear of the panel.
- MLPE devices may only be installed on REC solar panels in the areas shown in the diagram below (fig. 22 & 23):

Fig. 22: REC Alpha Series MLPE device installation zones

-  Installation of MLPE device in the green zone is permitted.
-  Installation of MLPE device in the red zone is not permitted.

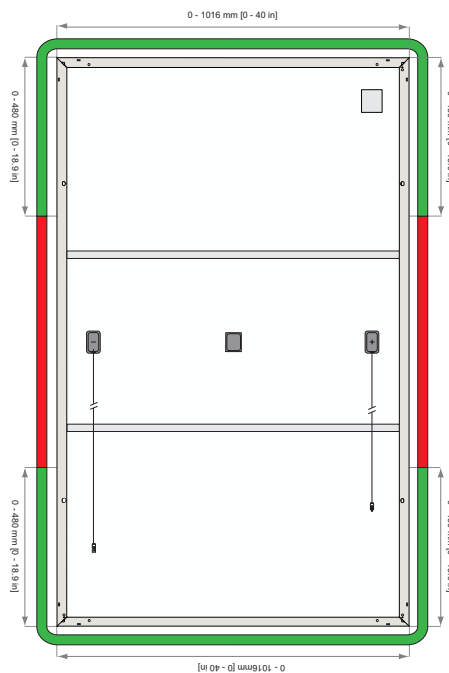
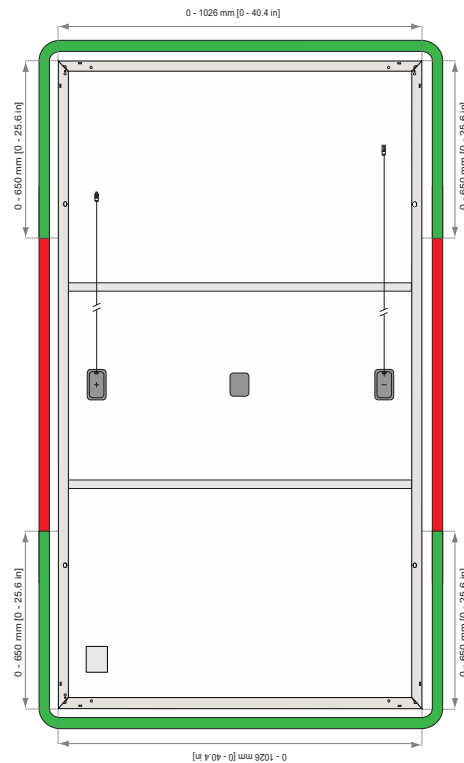

Fig. 23: REC Alpha 72 Series MLPE device installation zones



CAUTION

- To avoid damage to the panel and to allow for thermal expansion, there must be a minimum gap of 0.1 in (2.5 mm) between the MLPE device and the panel backsheet.
- The mounting holes in the panel frame must not be used for the installation of MLPE devices.
- The drilling of extra holes in the frame is not permitted and will invalidate the panel warranty.

CONNECTION

- First ensure the installation of the MLPE device is secure and safe.
- Following the device manufacturer's instructions to connect the cables from the MLPE device to the solar panel correctly (usually positive to positive [+ to +] and negative to negative [- to -]).
- Connection to the next panel in the array should be done from the 'free' cables.

SAFETY

- Immediately disconnect the device if there is a problem during installation.

ANNEX 3: SIX-POINT MOUNTING CONFIGURATION



This section is applicable to the following products only:

- REC Alpha Pure Series

A six-point mounting configuration secures the panel on three continuous rails (or other support structures) with three clamps on each side of the panel in the zones marked below:

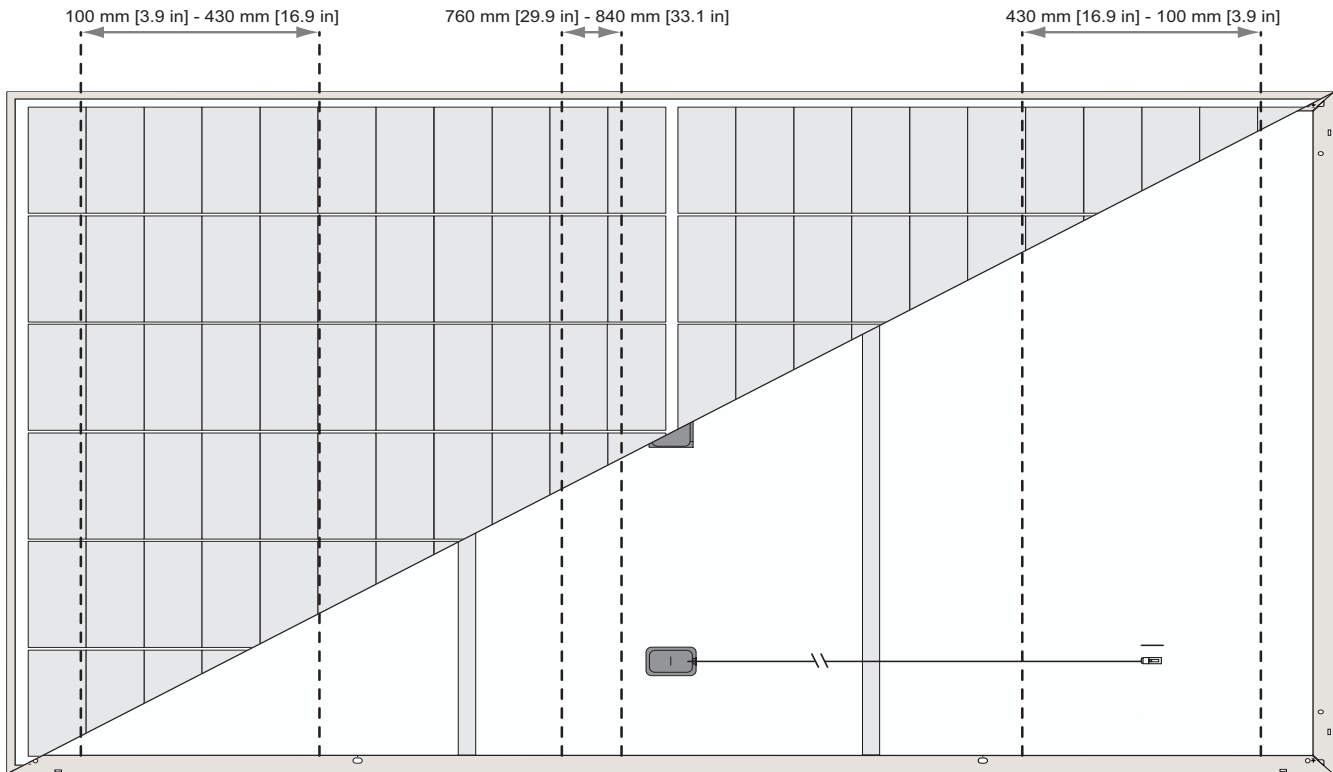
Fig. 24: Six-point mounting configuration clamping zones



Legend	Clearance Gap Clamping zone	0.8 - 1.6 in (20-40 mm)	1.6 - 2.4 in (40-60 mm)	>2.4 in (>60 mm)	<0.8 in (<20 mm)
		Test Load (Design Load)	Test Load (Design Load)	Test Load (Design Load)	Test Load (Design Load)
Rail position 	3.9 in - 16.9 in (100 - 430 mm)	+2000 Pa / -2000 Pa* (+1333Pa/-1333Pa)	+6300 Pa / -6000 Pa* (+4200Pa/-4000Pa)	+8000 Pa / -6000 Pa* (+5333Pa/-4000Pa)	X
	29.9 in - 33.1 in (760 - 840 mm)				
	Once a module is secured as described above (fig. 24), additional clamps, i.e., ≥ 7 , may be freely located on panel frame without affecting the warranty. Loads marked with a * were not certified as part of IEC 61215/61730 testing; these have been evaluated by REC's internal testing process.				

⚠ CAUTION

- The middle rail must not be installed on the side of the junction box where the cables exit.
- A total of three continuous rails (or other support structures) must be used to secure the panel.
- The center point of each clamp and the minimum grip length must be fully located within the marked zone to be rated to the given value (fig. 24).

DOCUMENT HISTORY

Date	Revision	Reason
04.2019	A	First release
08.2019	B	Updated Datasheet
10.2019	C	Mounting zones extended
06.2020	D	Addition of load specifications for different clearance gaps and rail lengths
09.2020	D2	Added minimum required torque for clamping
12.2020	E	Addition of REC Alpha 72 Series
03.2021	F	Updated Datasheets
06.2021	G	Addition of REC Alpha Pure Series
11.2021	H	Updated Datasheets
01.2022	I	Added six-point clamping and added requirement for washers when installing using mounting holes
04.2022	J	Updated "Connections and Connectors" chapter



REC SOLAR PTE. LTD.
20 TUAS SOUTH AVENUE 14
SINGAPORE 637312
Tel: +65 6495 9228
Mail: post@recgroup.com

www.recgroup.com